

P5M2-M Series



Motherboard

E2777

**First Edition
September 2006**

Copyright © 2006 ASUSTeK COMPUTER INC. All Rights Reserved.

No part of this manual, including the products and software described in it, may be reproduced, transmitted, transcribed, stored in a retrieval system, or translated into any language in any form or by any means, except documentation kept by the purchaser for backup purposes, without the express written permission of ASUSTeK COMPUTER INC. ("ASUS").

Product warranty or service will not be extended if: (1) the product is repaired, modified or altered, unless such repair, modification or alteration is authorized in writing by ASUS; or (2) the serial number of the product is defaced or missing.

ASUS PROVIDES THIS MANUAL "AS IS" WITHOUT WARRANTY OF ANY KIND, EITHER EXPRESS OR IMPLIED, INCLUDING BUT NOT LIMITED TO THE IMPLIED WARRANTIES OR CONDITIONS OF MERCHANTABILITY OR FITNESS FOR A PARTICULAR PURPOSE. IN NO EVENT SHALL ASUS, ITS DIRECTORS, OFFICERS, EMPLOYEES OR AGENTS BE LIABLE FOR ANY INDIRECT, SPECIAL, INCIDENTAL, OR CONSEQUENTIAL DAMAGES (INCLUDING DAMAGES FOR LOSS OF PROFITS, LOSS OF BUSINESS, LOSS OF USE OR DATA, INTERRUPTION OF BUSINESS AND THE LIKE), EVEN IF ASUS HAS BEEN ADVISED OF THE POSSIBILITY OF SUCH DAMAGES ARISING FROM ANY DEFECT OR ERROR IN THIS MANUAL OR PRODUCT.

SPECIFICATIONS AND INFORMATION CONTAINED IN THIS MANUAL ARE FURNISHED FOR INFORMATIONAL USE ONLY, AND ARE SUBJECT TO CHANGE AT ANY TIME WITHOUT NOTICE, AND SHOULD NOT BE CONSTRUED AS A COMMITMENT BY ASUS. ASUS ASSUMES NO RESPONSIBILITY OR LIABILITY FOR ANY ERRORS OR INACCURACIES THAT MAY APPEAR IN THIS MANUAL, INCLUDING THE PRODUCTS AND SOFTWARE DESCRIBED IN IT.

Products and corporate names appearing in this manual may or may not be registered trademarks or copyrights of their respective companies, and are used only for identification or explanation and to the owners' benefit, without intent to infringe.

Contents

Notices	vii
Safety information	viii
About this guide.....	ix
Typography	x
P5M2-M Series specifications summary	xi

Chapter 1: Product introduction

1.1	Welcome!	1-1
1.2	Package contents	1-1
1.3	Special features	1-2
1.3.1	Product highlights	1-2
1.3.2	Innovative ASUS features	1-4

Chapter 2: Hardware information

2.1	Before you proceed	2-1
	Onboard LED	2-1
2.2	Motherboard overview	2-2
	2.2.1 Placement direction	2-2
	2.2.2 Screw holes	2-2
	2.2.3 Motherboard layout	2-3
	2.2.4 Layout Contents	2-4
2.3	Central Processing Unit (CPU)	2-6
	2.3.1 Installing the CPU	2-6
	2.3.2 Installing the CPU heatsink and fan.....	2-9
	2.3.3 Uninstalling the CPU heatsink and fan.....	2-11
2.4	System memory.....	2-13
	2.4.1 Overview	2-13
	2.4.2 Memory Configurations	2-13
	2.4.3 Installing a DIMM	2-14
	2.4.4 Removing a DIMM.....	2-14
2.5	Expansion slots	2-15
	2.5.1 Installing an expansion card	2-15
	2.5.2 Configuring an expansion card	2-15
	2.5.3 Interrupt assignments.....	2-16
	2.5.4 PCI slot.....	2-17
	2.5.5 PCI Express x8 slot	2-17
2.6	Jumpers	2-18

Contents

- 2.7 Connectors 2-23
 - 2.7.1 Rear panel connectors 2-23
 - 2.7.2 Internal connectors 2-24

Chapter 3: Powering up

- 3.1 Starting up for the first time 3-1
- 3.2 Powering off the computer..... 3-2
 - 3.2.1 Using the OS shut down function 3-2
 - 3.2.2 Using the dual function power switch..... 3-2

Chapter 4: BIOS setup

- 4.1 Managing and updating your BIOS 4-1
 - 4.1.1 Creating a bootable floppy disk 4-1
 - 4.1.2 AFUDOS utility 4-2
 - 4.1.3 ASUS CrashFree BIOS 2 utility 4-5
 - 4.1.4 ASUS Update utility 4-7
- 4.2 BIOS setup program..... 4-10
 - 4.2.1 BIOS menu screen 4-11
 - 4.2.2 Menu bar 4-11
 - 4.2.3 Navigation keys..... 4-11
 - 4.2.4 Menu items 4-12
 - 4.2.5 Sub-menu items..... 4-12
 - 4.2.6 Configuration fields 4-12
 - 4.2.7 Pop-up window..... 4-12
 - 4.2.8 Scroll bar 4-12
 - 4.2.9 General help 4-12
- 4.3 Main menu..... 4-13
 - 4.3.1 System Time 4-13
 - 4.3.2 System Date 4-13
 - 4.3.3 Legacy Diskette A 4-13
 - 4.3.4 Primary, Third, Fourth Master/Slave 4-14
 - 4.3.5 IDE Configuration 4-15
 - 4.3.6 System Information..... 4-17
- 4.4 Advanced menu 4-18
 - 4.4.1 USB Configuration 4-18
 - 4.4.2 MPS Configuration..... 4-19

Contents

4.4.3	Remote Access Configuration.....	4-20
4.4.4	Trusted Computing	4-21
4.4.5	CPU Configuration	4-22
4.4.6	Chipset Configuration	4-23
4.4.7	Onboard Devices Configuration.....	4-25
4.4.8	PCI PnP	4-26
4.5	Power Configuration.....	4-27
4.5.1	APM Configuration	4-27
4.5.2	Hardware Monitor.....	4-29
4.6	Boot menu	4-31
4.6.1	Boot Device Priority	4-31
4.6.2	Hard Disk Drives.....	4-31
4.6.3	Boot Settings Configuration	4-32
4.6.4	Security.....	4-33
4.7	Exit menu.....	4-36

Chapter 5: RAID configuration

5.1	RAID Configurations.....	5-1
5.1.1	RAID definitions.....	5-1
5.1.2	Installing Serial ATA hard disks	5-2
5.1.3	Setting the RAID item in BIOS.....	5-2
5.1.4	RAID configuration utility	5-2
5.2	Intel Matrix Storage Manager Option ROM Utility.....	5-3
5.2.1	Creating a RAID 0 set (Striped).....	5-4
5.2.2	Creating a RAID 1 set (Mirror)	5-6
5.2.3	Creating a RAID 10 set (RAID 0+1)	5-7
5.2.4	Creating a RAID 5 set (Parity)	5-8
5.2.5	Deleting a RAID set	5-10
5.2.6	Resetting disks to Non-RAID.....	5-11
5.2.7	Existing the Intel Matrix Storage Manager utility ..	5-11
5.2.8	Rebuilding the RAID.....	5-12
5.2.9	Setting the Boot array in the BIOS Setup Utility...	5-13
5.3	LSI Logic Embedded SATA RAID Setup Utility	5-14
5.3.1	Creating a RAID set.....	5-21
5.3.2	Adding or viewing a RAID configuration.....	5-15
5.3.3	Initializing the logical drives	5-24

5.3.5	Checking the drives for data consistency	5-31
5.3.6	Deleting a RAID configuration	5-34
5.3.7	Selecting the boot drive from a RAID set	5-35
5.3.8	Enabling the WriteCache	5-36
5.4.	Global Array Manager	5-36

Chapter 6: Driver installation

6.1	RAID driver installation	6-1
6.1.1	Creating a RAID driver disk	6-1
6.1.2	Installing the RAID controller driver	6-2
6.2	LAN driver installation	6-12
6.2.1	Windows® 2000/2003 Server	6-12
6.2.2	Red Hat® Enterprise ver. 3.0	6-13
6.3	VGA driver installation	6-14
6.3.1	Windows® 2000 Server	6-14
6.3.2	Windows® 2003 Server	6-15
6.3.3	Red Hat® Enterprise ver. 3.0	6-15
6.4	Management applications and utilities installation	6-16
6.4.1	Running the support CD	6-16
6.4.2	Drivers menu	6-16
6.4.3	Management Software menu	6-17
6.4.4	Utilities menu	6-17
6.4.5	Contact information	6-18

Notices

Federal Communications Commission Statement

This device complies with Part 15 of the FCC Rules. Operation is subject to the following two conditions:

- This device may not cause harmful interference, and
- This device must accept any interference received including interference that may cause undesired operation.

This equipment has been tested and found to comply with the limits for a Class B digital device, pursuant to Part 15 of the FCC Rules. These limits are designed to provide reasonable protection against harmful interference in a residential installation. This equipment generates, uses and can radiate radio frequency energy and, if not installed and used in accordance with manufacturer's instructions, may cause harmful interference to radio communications. However, there is no guarantee that interference will not occur in a particular installation. If this equipment does cause harmful interference to radio or television reception, which can be determined by turning the equipment off and on, the user is encouraged to try to correct the interference by one or more of the following measures:

- Reorient or relocate the receiving antenna.
- Increase the separation between the equipment and receiver.
- Connect the equipment to an outlet on a circuit different from that to which the receiver is connected.
- Consult the dealer or an experienced radio/TV technician for help.



The use of shielded cables for connection of the monitor to the graphics card is required to assure compliance with FCC regulations. Changes or modifications to this unit not expressly approved by the party responsible for compliance could void the user's authority to operate this equipment.

Canadian Department of Communications Statement

This digital apparatus does not exceed the Class B limits for radio noise emissions from digital apparatus set out in the Radio Interference Regulations of the Canadian Department of Communications.

This class B digital apparatus complies with Canadian ICES-003.

Safety information

Electrical safety

- To prevent electrical shock hazard, disconnect the power cable from the electrical outlet before relocating the system.
- When adding or removing devices to or from the system, ensure that the power cables for the devices are unplugged before the signal cables are connected. If possible, disconnect all power cables from the existing system before you add a device.
- Before connecting or removing signal cables from the motherboard, ensure that all power cables are unplugged.
- Seek professional assistance before using an adapter or extension cord. These devices could interrupt the grounding circuit.
- Make sure that your power supply is set to the correct voltage in your area. If you are not sure about the voltage of the electrical outlet you are using, contact your local power company.
- If the power supply is broken, do not try to fix it by yourself. Contact a qualified service technician or your retailer.

Operation safety

- Before installing the motherboard and adding devices on it, carefully read all the manuals that came with the package.
- Before using the product, make sure all cables are correctly connected and the power cables are not damaged. If you detect any damage, contact your dealer immediately.
- To avoid short circuits, keep paper clips, screws, and staples away from connectors, slots, sockets and circuitry.
- Avoid dust, humidity, and temperature extremes. Do not place the product in any area where it may become wet.
- Place the product on a stable surface.
- If you encounter technical problems with the product, contact a qualified service technician or your retailer.



The symbol of the crossed out wheeled bin indicates that the product (electrical and electronic equipment) should not be placed in municipal waste. Check local regulations for disposal of electronic products.

About this guide

This user guide contains the information you need when installing and configuring the motherboard.

How this guide is organized

This manual contains the following parts:

- **Chapter 1: Product introduction**
This chapter describes the features of the motherboard and the new technology it supports.
- **Chapter 2: Hardware information**
This chapter lists the hardware setup procedures that you have to perform when installing system components. It includes description of the switches, jumpers, and connectors on the motherboard.
- **Chapter 3: Powering up**
This chapter describes the power up sequence, the vocal POST messages, and ways of shutting down the system.
- **Chapter 4: BIOS setup**
Tells how to change system settings through the BIOS Setup menus. Detailed descriptions of the BIOS parameters are also provided.
- **Chapter 5: RAID configuration**
Provides information on RAID configurations for this motherboard.
- **Chapter 6: Driver installation**
This chapter provides information on RAID and LAN driver installation for this motherboard.
- **Appendix: Reference information**
This appendix includes additional information that you may refer to when configuring the motherboard.

Where to find more information

Refer to the following sources for additional information and for product and software updates.

1. **ASUS websites**
The ASUS website provides updated information on ASUS hardware and software products. Refer to the ASUS contact information.
2. **Optional documentation**
Your product package may include optional documentation, such as warranty flyers, that may have been added by your dealer. These documents are not part of the standard package.

Conventions used in this guide

To make sure that you perform certain tasks properly, take note of the following symbols used throughout this manual.



DANGER/WARNING: Information to prevent injury to yourself when trying to complete a task.



CAUTION: Information to prevent damage to the components when trying to complete a task.



IMPORTANT: Instructions that you **MUST** follow to complete a task.



NOTE: Tips and additional information to help you complete a task.

Typography

Bold text

Indicates a menu or an item to select.

Italics

Used to emphasize a word or a phrase.

<Key>

Keys enclosed in the less-than and greater-than sign means that you must press the enclosed key.

Example: <Enter> means that you must press the Enter or Return key.

<Key1> + <Key2> + <Key3>

If you must press two or more keys simultaneously, the key names are linked with a plus sign (+).

Example: <Ctrl> + <Alt> +

Command

Means that you must type the command exactly as shown, then supply the required item or value enclosed in brackets.

Example: At the DOS prompt, type the command line: `format A:/S`

P5M2-M Series specifications summary

CPU	LGA775 socket for Intel® Pentium®4/processor Compatible with Intel® PCG 06/05B/05A and 04B/04A and the latest Intel® dual-core processor Supports Intel® Enhanced Memory 64 Technology (EM64T) Supports Enhanced Intel SpeedStep® Technology (EIST) Supports Intel® Hyper-Threading Technology
Chipset	NorthBridge: Intel® Mukilteo-2 SouthBridge: Intel® ICH7R
Front Side Bus	1066/800/533 MHz
Memory	Dual-channel memory architecture 4 x 240-pin DIMM sockets support unbuffered ECC/non-ECC DDR2-533/667 memory modules Supports up to 8 GB system memory
Expansion slots *	1 x PCI-E1 X8 slot (x4 link) 1 x PCI-E2 X8 slot (x8 link) 2 x PCI 33 MHz/32-bit/5V slots (PCI 2.2)
Storage	Intel® ICH7R Southbridge supports: <ul style="list-style-type: none"> - 2 x Ultra ATA 100/66/33 hard disk drives - 4 x SATAII drives with RAID functionality or IAA(RAID 0, RAID 1, RAID 0+1, and RAID 5), or LSI (RAID 0, RAID 1, RAID 0+1) (<i>For P5M2-M model only</i>)
Graphics	Volari® XGI Z7 PCI-based VGA controller
LAN	Dual embedded Broadcom BCM5721 Gigabit LAN controllers that comply with PCI Express 1.0a specifications (for P5M2-M model) Single embedded Broadcom BCM5721 Gigabit LAN controllers that comply with PCI Express 1.0a specifications (for P5M2-M/C model)
USB	Intel ICH7R Southbridge supports: <ul style="list-style-type: none"> - 4 USB 2.0 ports (two on the rear panel, two on the board)
Special features	ASUS CrashFree BIOS 2 ASUS MyLogo2 Smart-fan BIOS Recovery
BIOS features	AMI BIOS, 8 MB Flash ROM, Green, PnP, DMI, SMBIOS 2.3, WfM2.0, ACPI 2.0a

(continued on the next page)

P5M2-M Series specifications summary

Rear panel	1 x PS/2 keyboard port (purple) 1 x PS/2 mouse port (green) 2 x USB 2.0 ports 1 x Parallel port 1 x Serial port (COM1) 1 x VGA port 2 x LAN (RJ-45) ports (For P5M2-M) 1 x LAN (RJ-45) port (For P5M2-M/C)
Internal connectors	1 x Floppy disk drive connector 1 x IDE connector 4 x Serial ATA connectors 2 x Front fan connectors 2 x Rear fan connectors 2 x CPU fan connectors 1 x 24-pin ATX power connector 1 x 4-pin ATX 12 V power connector 1 x Power supply SMBUS connector 1 x Serial port (COM2) 1 x USB connector for one additional USB1.1 and USB 2.0 ports 1 x 20-1 pin auxiliary panel connector 1 x 20-1 pin system panel connector
Power Requirement	SSI power supply (with 24-pin and 4-pin 12 V plugs) ATX 12 V 2.0 compliant
Form Factor	ATX form factor: 9.6 in x 9.6 in (24.5 cm x 24.5 cm)
Support CD contents	Device drivers ASUS Live Update utility ASUS Server Web-based Management (ASWM)

**Specifications are subject to change without notice.*

This chapter describes the motherboard features and the new technologies it supports.

1 **Product introduction**

Chapter summary



- 1.1 Welcome! 1-1
- 1.2 Package contents 1-1
- 1.3 Special features 1-2

1.1 Welcome!

Thank you for buying an ASUS® P5M2-M Series motherboard!

The motherboard delivers a host of new features and latest technologies, making it another standout in the long line of ASUS quality motherboards!

Before you start installing the motherboard, and hardware devices on it, check the items in your package with the list below.

1.2 Package contents

Check your motherboard package for the following items.

Motherboard	ASUS P5M2-M Series motherboard
Cables	4 x Serial ATA signal cables 2 x Serial ATA power cables 2-in-1 Floppy/Ultra ATA disk drive cable
Accessories	I/O shield
Application CDs	ASUS motherboard support CD
Documentation	User guide



If any of the above items is damaged or missing, contact your retailer.

1.3 Special features

1.3.1 Product highlights

Latest processor technology

The motherboard comes with a 775-pin surface mount Land Grid Array (LGA) socket designed for the Intel® Pentium® 4 processor in the 775-land package. The motherboard supports the Intel® Pentium® 4 processor with 1066/800 MHz Front Side Bus (FSB). The motherboard also supports the Intel® Hyper-Threading Technology and is fully compatible with Intel® O6, O5B/O5A or O4B/O4A processors. See page 2-6 for details.

Intel® EM64T



The motherboard supports Intel® Pentium® 4 CPUs with the Intel® EM64T (Extended Memory 64 Technology). The Intel® EM64T feature allows your computer to run on 64-bit operating systems and access larger amounts of system memory for faster and more efficient computing.

Enhanced Intel SpeedStep® Technology (EIST)

The Enhanced Intel SpeedStep® Technology (EIST) intelligently manages the CPU resources by automatically adjusting the CPU voltage and core frequency depending on the CPU loading and system speed or power requirement.

Intel® E3000 and Intel® ICH7R chipset

The Intel® E3000 Memory Controller Hub (MCH) and the Intel® ICH7R (I/O controller hub) provide the vital interfaces for the motherboard.

The MCH provides the processor, dual-channel DDR2-533/667 memory, and PCI Express interfaces. The ICH7R is a new generation server class I/O controller hub that provides the interface for PCI 2.3, USB 2.0, and SATA among others.

DDR2-667 memory support



The motherboard supports DDR2 memory which features data transfer rates of up to 667 MHz to meet the higher bandwidth requirements of the latest server applications. The dual-channel memory architecture doubles the bandwidth of your system memory to boost system performance, eliminating bottlenecks with peak bandwidths of up to 10.7 GB/s.

PCI Express™ interface



The motherboard fully supports PCI Express, the latest I/O interconnect technology that speeds up the PCI bus. PCI Express features point-to-point serial interconnections between devices and allows higher clockspeeds by carrying data in packets. This high speed interface is software compatible with existing PCI or PCI-X specifications. See page 2-17 for details.

Gigabit LAN solution

The motherboard comes with dual Gigabit LAN controllers and ports to provide a total solution for your networking needs. The onboard Broadcom® BCM5721 Gigabit LAN controllers use the PCI Express interface and could achieve network throughput close to Gigabit bandwidth. See page 2-23 for details.

Serial ATA II technology

The motherboard supports the Serial ATA II technology through the Serial ATA interfaces controlled by the Intel® ICH7R. The SATA specification allows for thinner, more flexible cables with lower pin count, reduced voltage requirement, and up to 300 MB/s data transfer rate.

Built-in SATA RAID solution

The Intel® ICH7R allows RAID 0, RAID 1, RAID 0+1, and RAID 5 configuration for SATA hard disk drives via the Intel® Matrix Storage Manager (under Windows Operating System) or the LSI Logic Embedded SATA RAID Setup Utility (no RAID 5). See page 2-26 and Chapter 5 for details.

USB 2.0 technology

The motherboard implements the Universal Serial Bus (USB) 2.0 specification, dramatically increasing the connection speed from the 12 Mbps bandwidth on USB 1.1 to a fast 480 Mbps on USB 2.0. USB 2.0 is backward compatible with USB 1.1. See pages 2-23 and 2-27 for details.

Temperature, fan, and voltage monitoring

The CPU temperature is monitored by the ASIC (integrated in the Winbond hardware monitor) to prevent overheating and damage. The system fan rotations per minute (RPM) is monitored for timely failure detection. The ASIC monitors the voltage levels to ensure stable supply of current for critical components. See page 4-30 for details.

1.3.2 Innovative ASUS features

CrashFree BIOS 2

This feature allows you to restore the original BIOS data from the support CD in case when the BIOS codes and data are corrupted. This protection eliminates the need to buy a replacement ROM chip. See page 4-5 for details.

ASUS MyLogo2™

This new feature present in the motherboard allows you to personalize and add style to your system with customizable boot logos. See page 4-32 for details.

ASUS Smart Fan technology I

The ASUS Smart Fan technology smartly adjusts the fan speeds according to the system loading to ensure quiet, cool, and efficient operation.

This chapter lists the hardware setup procedures that you have to perform when installing system components. It includes description of the jumpers and connectors on the motherboard.

Hardware 2 information

2.1	Before you proceed	2-1
2.2	Motherboard overview	2-2
2.3	Central Processing Unit (CPU)	2-6
2.4	System memory.....	2-13
2.5	Expansion slots	2-15
2.6	Jumpers	2-18
2.7	Connectors	2-23

2.1 Before you proceed

Take note of the following precautions before you install motherboard components or change any motherboard settings.



- Unplug the power cord from the wall socket before touching any component.
- Use a grounded wrist strap or touch a safely grounded object or a metal object, such as the power supply case, before handling components to avoid damaging them due to static electricity.
- Hold components by the edges to avoid touching the ICs on them.
- Whenever you uninstall any component, place it on a grounded antistatic pad or in the bag that came with the component.
- **Before you install or remove any component, ensure that the ATX power supply is switched off or the power cord is detached from the power supply.** Failure to do so may cause severe damage to the motherboard, peripherals, or components, or all of the above articles.

Onboard LED

The motherboard comes with a standby power LED. The green LED lights up to indicate that the system is ON, in sleep mode, or in soft-off mode. This is a reminder that you should shut down the system and unplug the power cable before removing or plugging in any motherboard component. The illustration below shows the location of the onboard LED.

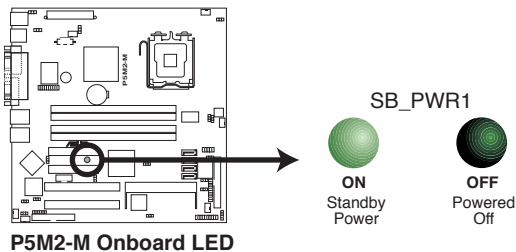

2.2 Motherboard overview

Before you install the motherboard, study the configuration of your chassis to ensure that the motherboard fits into it.

To optimize the motherboard features, we highly recommend that you install it in an **SSI EEB 3.5 compliant chassis**.



Make sure to unplug the power cord before installing or removing the motherboard. Failure to do so can cause you physical injury and damage to the motherboard components.

2.2.1 Placement direction

When installing the motherboard, make sure that you place it into the chassis in the correct orientation. The edge with external ports goes to the rear part of the chassis as indicated in the image below.

2.2.2 Screw holes

Place nine (8) screws into the holes indicated by circles to secure the motherboard to the chassis.



Do not overtighten the screws! Doing so can damage the motherboard.

Place this side towards the rear of the chassis

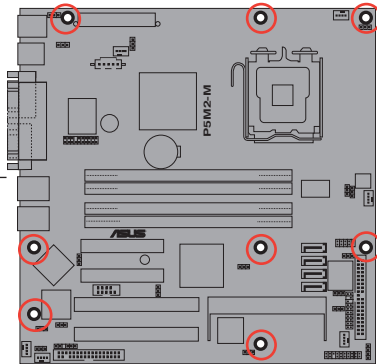

2.2.3 Motherboard layout

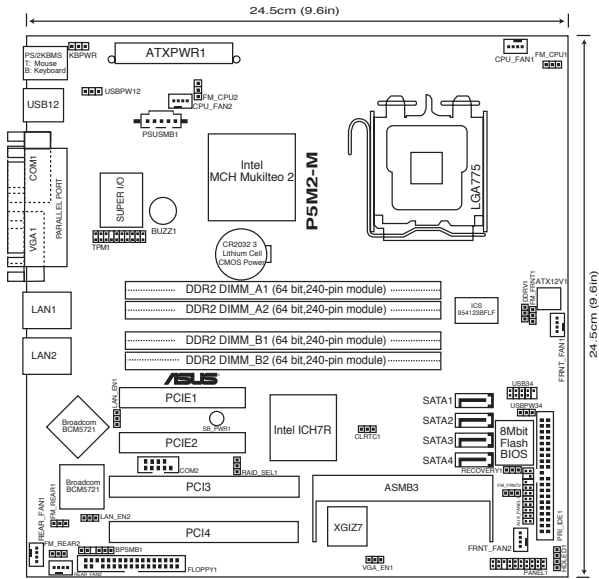

P5M2-M Layout

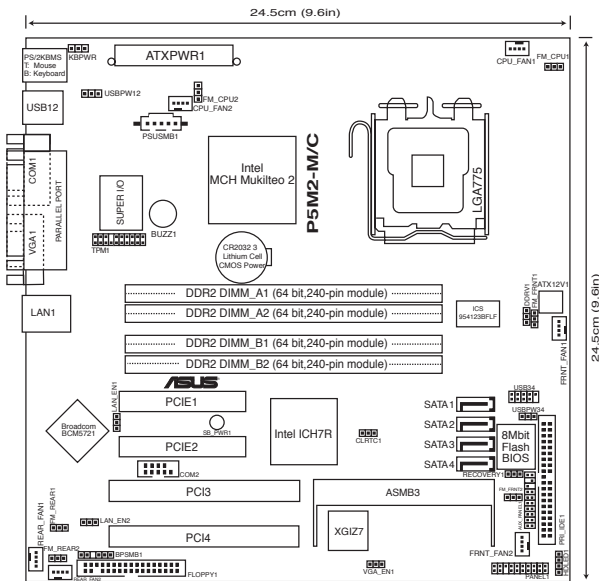

P5M2-M/C Layout

2.2.4 Layout contents

Slots/Sockets		Page
1.	CPU socket	2-6
2.	DDR2 DIMM slots	2-13
3.	PCI/PCI Express slots	2-17

Jumpers		Page
1.	Clear RTC RAM (CLRTC1)	2-18
2.	CPU fan pin selection (3-pin FM_CPU1, FM_CPU2)	2-19
3.	USB device wake-up (3-pin USBPW12, USBPW34)	2-19
4.	Keyboard/Mouse power (3-pin KBPWR1)	2-20
5.	VGA controller setting (3-pin VGA_EN1)	2-20
6.	Gigabit LAN controller setting (3-pin LAN_EN1; LAN_EN2)	2-21
7.	RAID controller selection (3-pin RAID_SEL1)	2-21
8.	Force BIOS recovery setting (3-pin RECOVERY1)	2-22

Rear panel connectors		Page
1.	PS/2 mouse port (green)	2-23
2.	Parallel port	2-23
3.	Gigabit LAN1 (RJ-45) port	2-23
4.	Gigabit LAN2 (RJ-45) port	2-23
5.	VGA port	2-23
6.	Serial (COM1) port	2-23
7.	USB 2.0 ports 1 and 2	2-23
8.	PS/2 keyboard port (purple)	2-23

Internal connectors		Page
1.	Floppy disk drive connector (34-1 pin FLOPPY1)	2-24
2.	ICH7R primary IDE connectors (40-1 pin PRI_IDE1)	2-25
3.	Serial ATA connectors (7-pin SATA1, SATA2, SATA3, SATA4)	2-26
4.	Hard disk activity LED connector (4-pin HDLED1)	2-27
5.	USB connector (10-1 pin USB34)	2-27
6.	Serial port connector (10-1 pin COM2)	2-28
7.	CPU and system fan connectors (3-pin CPU_FAN1/2, REAR_FAN1/2, FRNT_FAN1/2)	2-28
8.	Backplane SMBus connector (6-1 pin BPSMB1)	2-29
9.	Power supply SMBus connector (5-pin PSUSMB1)	2-29
10.	SSI power connectors (24-pin ATXPWR1, 8-pin ATX12V2)	2-30
11.	Auxiliary panel connector (20-pin AUX_PANEL1)	2-31
12.	System panel connector (20-pin PANEL1)	2-32

2.3 Central Processing Unit (CPU)

The motherboard comes with a surface mount LGA775 socket designed for the Intel® Pentium® 4 in the 775-land package.



- Upon purchase of the motherboard, make sure that the PnP cap is on the socket and the socket contacts are not bent. Contact your retailer immediately if the PnP cap is missing, or if you see any damage to the PnP cap/socket contacts/motherboard components. ASUS shoulders the repair cost only if the damage is shipment/transit-related.
- Keep the cap after installing the motherboard. ASUS will process Return Merchandise Authorization (RMA) requests only if the motherboard comes with the cap on the LGA775 socket.
- The product warranty does not cover damage to the socket contacts resulting from incorrect CPU installation/removal, or misplacement/loss/incorrect removal of the PnP cap.

2.3.1 Installing the CPU

To install a CPU:

1. Locate the CPU socket on the motherboard.

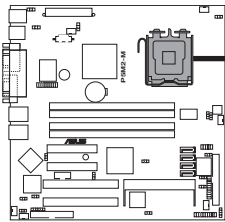

P5M2-M CPU Socket 775



Before installing the CPU, make sure that the cam box is facing towards you and the load lever is on your left.

2. Press the load lever with your thumb (A), then move it to the left (B) until it is released from the retention tab.

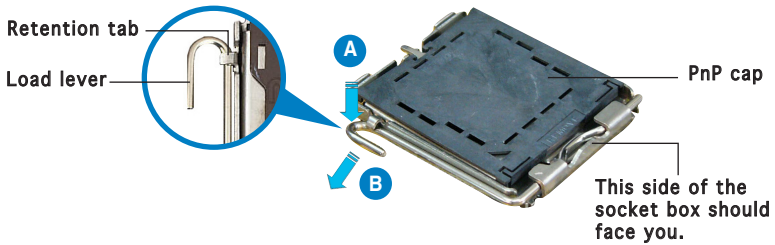

To prevent damage to the socket pins, do not remove the PnP cap unless you are installing a CPU.

3. Lift the load lever in the direction of the arrow to a 135° angle.

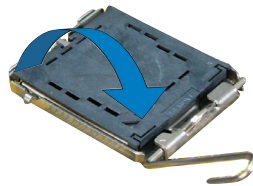

4. Lift the load plate with your thumb and forefinger to a 100° angle (A), then push the PnP cap from the load plate window to remove (B).

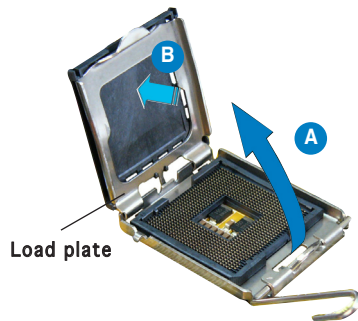

5. Position the CPU over the socket, making sure that the gold triangle is on the bottom-left corner of the socket. The socket alignment key should fit into the CPU notch.

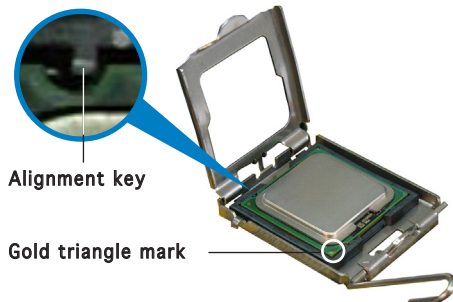



The CPU fits in only one correct orientation. DO NOT force the CPU into the socket to prevent bending the connectors on the socket and damaging the CPU!

6. Close the load plate (A), then push the load lever (B) until it snaps into the retention tab.

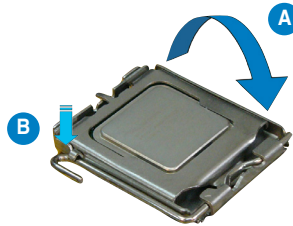

The motherboard supports Intel® Pentium® 4 LGA775 processors with the Intel® Enhanced Memory 64 Technology (EM64T), Enhanced Intel SpeedStep® Technology (EIST), and Hyper-Threading Technology. Refer to the Appendix for more information on these CPU features.

2.3.2 Installing the CPU heatsink and fan

The Intel® Pentium® 4 LGA775 processor requires a specially designed heatsink and fan assembly to ensure optimum thermal condition and performance.



- When you buy a boxed Intel® Pentium® 4 processor, the package includes the CPU fan and heatsink assembly.
- Your Intel® Pentium® 4 LGA775 heatsink and fan assembly comes in a push-pin design and requires no tool to install.
- If you purchased a separate CPU heatsink and fan assembly, make sure that you have properly applied Thermal Interface Material to the CPU heatsink or CPU before you install the heatsink and fan assembly.



- Make sure that you use Intel®-certified multi-directional heatsink and fan only.
- Make sure that you have installed the motherboard to the chassis before you install the CPU fan and heatsink assembly.

To install the CPU heatsink and fan:

1. Place the heatsink on top of the installed CPU, making sure that the four fasteners match the holes on the motherboard.



Orient the heatsink and fan assembly such that the CPU fan cable is closest to the CPU fan connector.

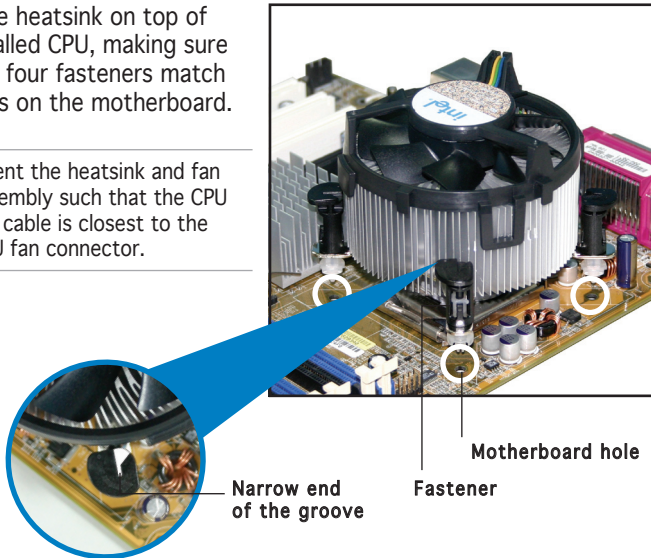

Make sure to orient each fastener with the narrow end of the groove pointing outward. (The photo shows the groove shaded for emphasis.)

2. Push down two fasteners at a time in a diagonal sequence to secure the heatsink and fan assembly in place.

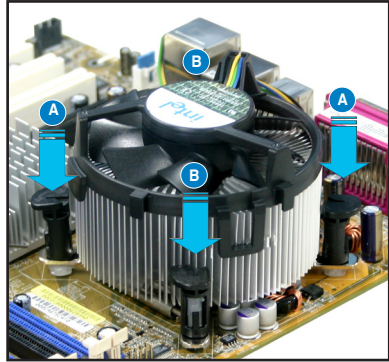
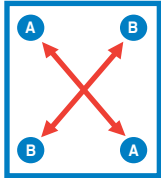

3. Connect the CPU fan cable to the connector on the motherboard labeled CPU_FAN1/CPU_FAN2.

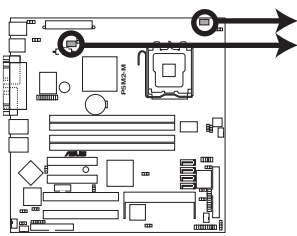

P5M2-M CPU Fan Connectors

CPU_FAN1

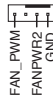

CPU_FAN2



- Do not forget to connect the CPU fan connector! Hardware monitoring errors can occur if you fail to plug this connector.
- If there is only one CPU fan cable, connect it to the connector labeled CPU_FAN1. Failure to do so may cause hardware monitoring errors. Set the CPU fan pin selection jumper to use a 3-pin or 4-pin fan cable plug. Refer to “2.6 Jumpers” for details.

2.3.3 Uninstalling the CPU heatsink and fan

To uninstall the CPU heatsink and fan:

1. Disconnect the CPU fan cable from the connector on the motherboard.
2. Rotate each fastener counterclockwise.

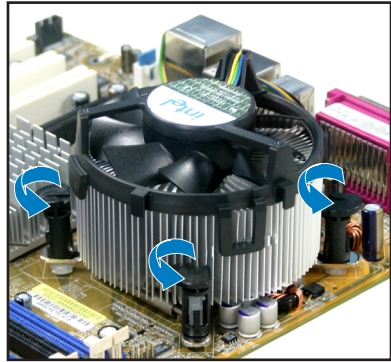

3. Pull up two fasteners at a time in a diagonal sequence to disengage the heatsink and fan assembly from the motherboard.

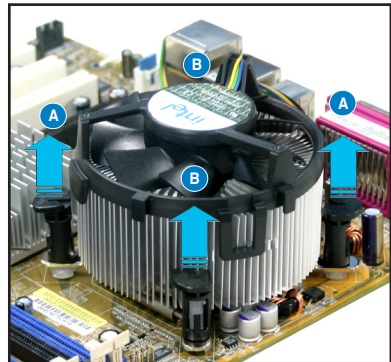
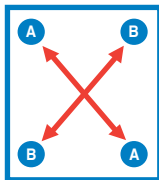

4. Carefully remove the heatsink and fan assembly from the motherboard.

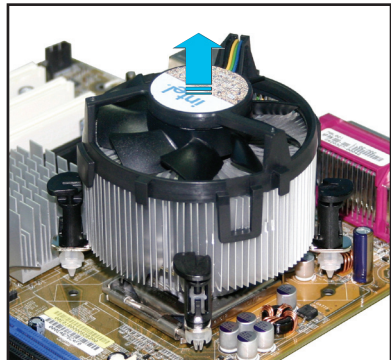

5. Rotate each fastener clockwise to ensure correct orientation when reinstalling.

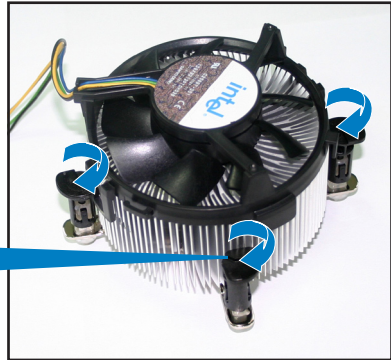
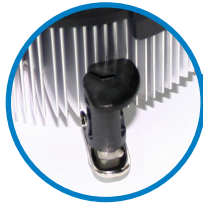

Narrow end of the groove



The narrow end of the groove should point outward after resetting. (The photo shows the groove shaded for emphasis.)

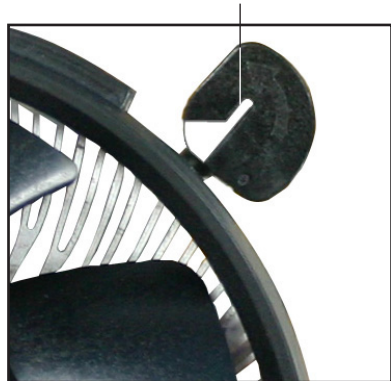

Refer to the documentation in the boxed or stand-alone CPU fan package for detailed information on CPU fan installation.

2.4 System memory

2.4.1 Overview

The motherboard comes with four Double Data Rate 2 (DDR2) Dual Inline Memory Modules (DIMM) sockets.

A DDR2 module has the same physical dimensions as a DDR DIMM but has a 240-pin footprint compared to the 184-pin DDR DIMM. DDR2 DIMMs are notched differently to prevent installation on a DDR DIMM socket.

The figure illustrates the location of the DDR2 DIMM sockets:

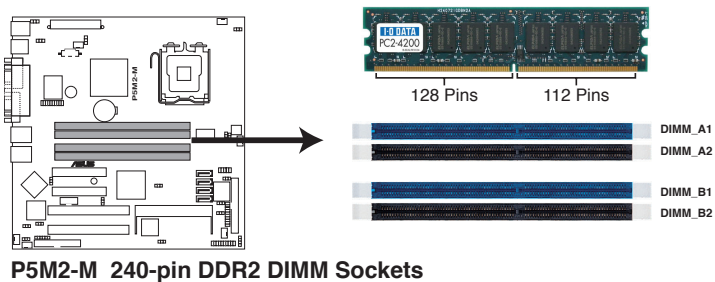

2.4.2 Memory configurations

You may install 256 MB, 512 MB, 1 GB, and 2 GB unbuffered ECC or non-ECC DDR2-533/667 DIMMs into the DIMM sockets.



- Always install DIMMs with the same CAS latency. For optimum compatibility, we recommend that you obtain memory modules from the same vendor. Refer to the DDR2 Qualified Vendors List on the ASUS web site.
- When installing one or two DIMMs, install the DIMM(s) to the blue slots (DIMM_A1/DIMM_B1).
- Three DDR2 DIMMs installed into any three memory sockets will function in single-channel mode.

2.4.3 Installing a DIMM



Unplug the power supply before adding or removing DIMMs or other system components. Failure to do so can cause severe damage to both the motherboard and the components.

To install a DIMM:

1. Unlock a DIMM socket by pressing the retaining clips outward.
2. Align a DIMM on the socket such that the notch on the DIMM matches the break on the socket.
3. Firmly insert the DIMM into the socket until the retaining clips snap back in place and the DIMM is properly seated.

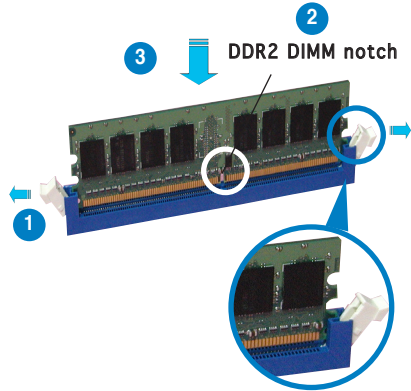

Unlocked retaining clip



- A DDR2 DIMM is keyed with a notch so that it fits in only one direction. DO NOT force a DIMM into a socket to avoid damaging the DIMM.
- The DDR2 DIMM sockets do not support DDR DIMMs. DO NOT install DDR DIMMs to the DDR2 DIMM sockets.

2.4.4 Removing a DIMM

Follow these steps to remove a DIMM.

1. Simultaneously press the retaining clips outward to unlock the DIMM.



Support the DIMM lightly with your fingers when pressing the retaining clips. The DIMM might get damaged when it flips out with extra force.

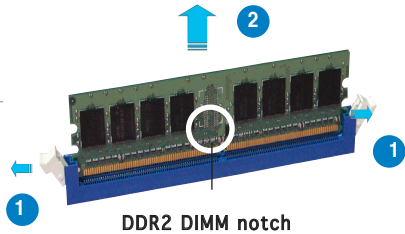

2. Remove the DIMM from the socket.

2.5 Expansion slots

In the future, you may need to install expansion cards. The following sub-sections describe the slots and the expansion cards that they support.



Make sure to unplug the power cord before adding or removing expansion cards. Failure to do so may cause you physical injury and damage to the motherboard components.

2.5.1 Installing an expansion card

To install an expansion card:

1. Before installing the expansion card, read the documentation that came with it and make the necessary hardware settings for the card.
2. Remove the system unit cover (if your motherboard is already installed in a chassis).
3. Remove the bracket opposite the slot that you intend to use. Keep the screw for later use.
4. Align the card connector with the slot and press firmly until the card is completely seated on the slot.
5. Secure the card to the chassis with the screw you removed earlier.
6. Replace the system cover.

2.5.2 Configuring an expansion card

After installing the expansion card, configure it by adjusting the software settings.

1. Turn on the system and change the necessary BIOS settings, if any. See Chapter 4 for information on BIOS setup.
2. Assign an IRQ to the card. Refer to the tables on the next page.
3. Install the software drivers for the expansion card.



When using PCI cards on shared slots, ensure that the drivers support “Share IRQ” or that the cards do not need IRQ assignments. Otherwise, conflicts will arise between the two PCI groups, making the system unstable and the card inoperable. Refer to the table on the next page for details.

2.5.3 Interrupt assignments

Standard interrupt assignments

IRQ	Priority	Standard Function
0	1	System Timer
1	2	Keyboard Controller
2	—	Re-direct to IRQ#9
3*	11	Communications Port (COM2)
4*	12	Communications Port (COM1)
5*	13	IRQ holder for PCI steering
6	14	Floppy Disk Controller
7*	15	Printer Port (LPT1)
8	3	System CMOS/Real Time Clock
9*	4	IRQ holder for PCI steering
10*	5	IRQ holder for PCI steering
11*	6	IRQ holder for PCI steering
12*	7	PS/2 Compatible Mouse Port
13	8	Numeric Data Processor
14	9	Primary IDE Channel
15	10	Secondary IDE Channel

* These IRQs are usually available for ISA or PCI devices.

PCI Bus Number, IDSEL, and IRQ assignments

Description	INTA	INTB	INTC	INTD	REQ#	GNT#
PCI Slot 1	PIRQE#	PIRQF#	PIRQG#	PIRQH#	REQ0	GNT0
PCI Slot 2	PIRQG#	PIRQH#	PIRQE#	PIRQF#	REQ0	GNT0
PCI Express Slot (x8)		PIRQB#	—	—	—	—
PCI Express Slot (x8)		PIRQB#	—	—	—	—
Onboard USB Controller1		PIRQB#	—	—	—	—
Onboard USB Controller2	PIRQA#	—	—	—	—	—
Onboard USB2.0 Controller		PIRQB#	—	—	—	—
Onboard PCI E X1 LAN1	INTA#	—	—	—	—	—
Onboard PCI E X1 LAN2	—	INTB#	—	—	—	—
Onboard VGA	—	—	—	—	—	—

2.5.4 PCI slot

The PCI slot supports cards such as a LAN card, SCSI card, USB card, and other cards that comply with PCI specifications. The figure shows a LAN card installed on a PCI slot.



2.5.5 PCI Express x8 slot

This motherboard supports PCI Express x8 cards that comply with the PCI Express specifications.

2.6 Jumpers

1. Clear RTC RAM (CLRTC1)

This jumper allows you to clear the Real Time Clock (RTC) RAM in CMOS. You can clear the CMOS memory of date, time, and system setup parameters by erasing the CMOS RTC RAM data. The onboard button cell battery powers the RAM data in CMOS, which include system setup information such as system passwords.

To erase the RTC RAM:

1. Turn OFF the computer and unplug the power cord.
2. Remove the onboard battery.
3. Move the jumper cap from pins 1-2 (default) to pins 2-3. Keep the cap on pins 2-3 for about 5~10 seconds, then move the cap back to pins 1-2.
4. Re-install the battery.
5. Plug the power cord and turn ON the computer.
6. Hold down the key during the boot process and enter BIOS setup to re-enter data.



Except when clearing the RTC RAM, never remove the cap on CLRTC jumper default position. Removing the cap will cause system boot failure!

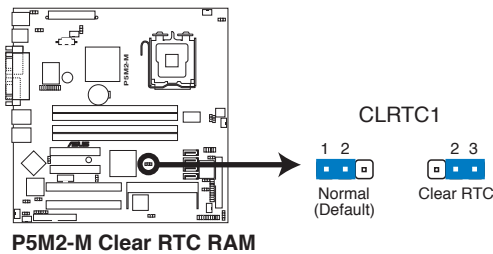

2. CPU fan pin selection (3-pin FM_CPU1, FM_CPU2)

These jumpers allow you to connect either a 3-pin or a 4-pin fan cable plug to the CPU fan connectors (CPU_FAN1, CPU_FAN2). Set these jumpers to pins 1-2 if you are using a 3-pin fan cable plug, or to pins 2-3 if you are using a 4-pin plug.

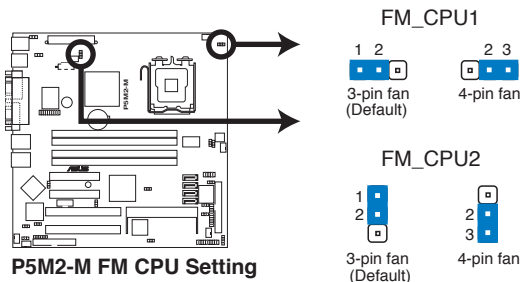

3. USB device wake-up (3-pin USBPW12, USBPW34)

Set these jumpers to +5V to wake up the computer from S1 sleep mode (CPU stopped, DRAM refreshed, system running in low power mode) using the connected USB devices. Set to +5VSB to wake up from S4 sleep mode (no power to CPU, DRAM in slow refresh, power supply in reduced power mode).

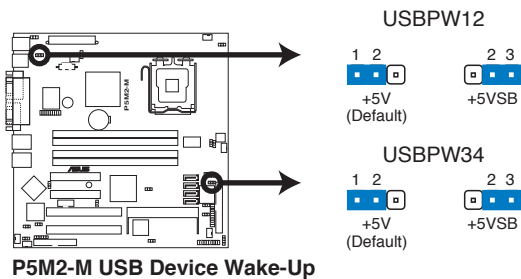

- The USB device wake-up feature requires a power supply that can provide 500mA on the +5VSB lead for each USB port; otherwise, the system would not power up.
- If you are using Windows 2000, you need to install Service Pack 4 to wake up the system from S4 sleep mode.
- The total current consumed must NOT exceed the power supply capability (+5VSB) whether under normal condition or in sleep mode.

4. Keyboard/Mouse power (3-pin KBPWR1)

This jumper allows you to enable or disable the keyboard/mouse wake-up feature. Set this jumper to pins 2-3 (+5VSB) to wake up the computer when you press a key on the keyboard (the default is the Space Bar) or use the mouse. This feature requires an ATX power supply that can supply at least 1A on the +5VSB lead, and a corresponding setting in the BIOS.

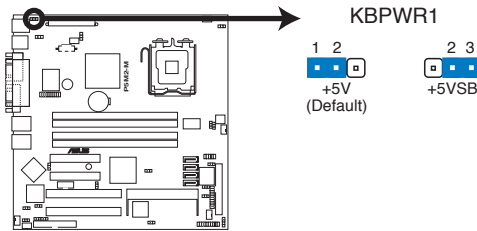

P5M2-M Keyboard Power Setting

5. VGA controller setting (3-pin VGA_EN1)

These jumpers allow you to enable or disable the onboard XGI Volari Z7® PCI VGA controller. Set to pins 1-2 to activate the VGA feature.

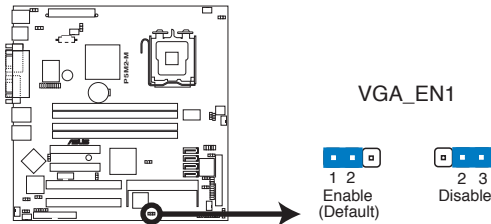

P5M2-M VGA Setting

6. Gigabit LAN controller setting [3-pin LAN_EN1, LAN_EN2 (for P5M2-M model only)]

These jumpers allow you to enable or disable the onboard Broadcom® BCM5721 Gigabit LAN1 or LAN2 controller. Set to pins 1-2 to activate the Gigabit LAN controller.

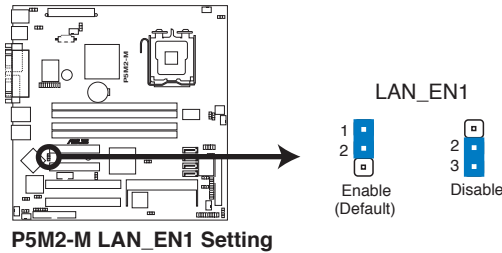

(For P5M2-M model only)

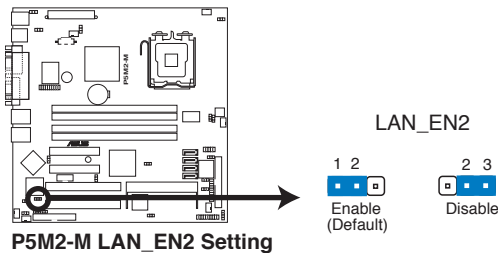

7. RAID controller selection (3-pin RAID_SEL1) (For P5M2-M model only)

This jumper allows you to select the RAID configuration utility to use when you create disk arrays. Place the jumper caps over pins 1-2 if you want to use the LSI Logic Embedded SATA RAID Setup Utility (default); otherwise, place the jumper caps to pins 2-3 to use the Intel® Matrix Storage Manager.

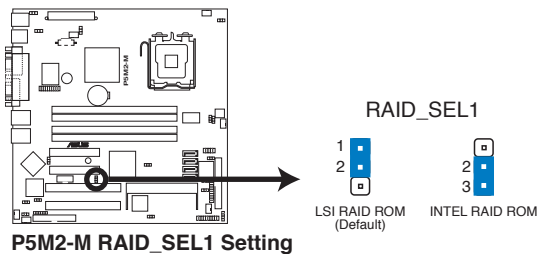

8. Force BIOS recovery setting (3-pin RECOVERY1)

This jumper allows you to quickly update or recover the BIOS when it gets corrupted.

To update the BIOS:

1. Prepare a floppy disk that contains the latest BIOS for the motherboard (xxxx-xxx.ROM) and the AFUDOS.EXE utility.
2. Set the jumper to pins 2-3.
3. Insert the floppy disk then turn on the system to update the BIOS.
4. Shut down the system.
5. Set the jumper back to pins 1-2.
6. Turn on the system.

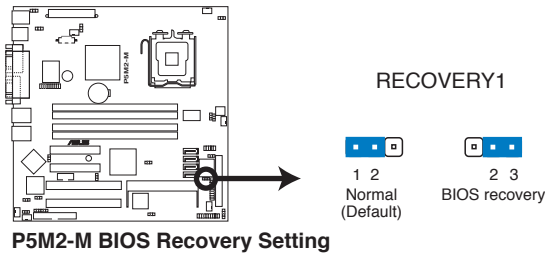

2.7 Connectors

2.7.1 Rear panel connectors

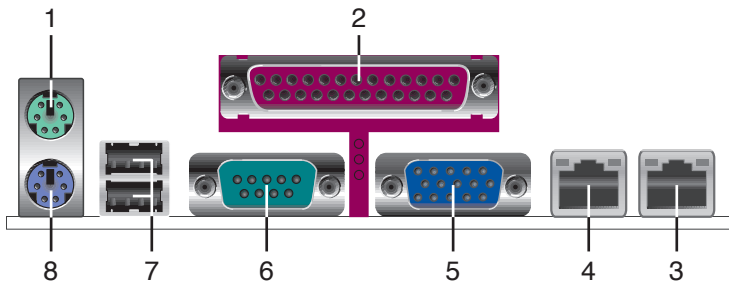

Rear Panel of P5M2-M

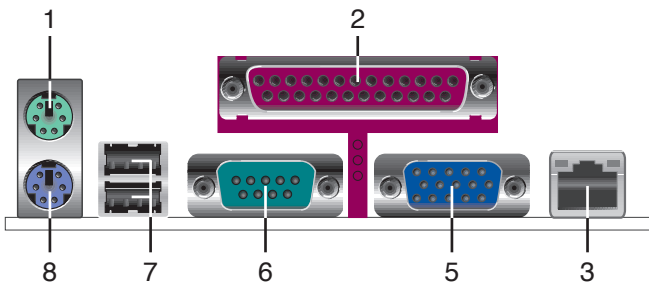

Rear Panel of P5M2-M/C

1. **PS/2 mouse port (green).** This port is for a PS/2 mouse.
2. **Parallel port.** This 25-pin port connects a parallel printer, a scanner, or other devices.
3. **Gigabit LAN1 (RJ-45) port.** This ports allow Gigabit connection to a Local Area Network (LAN) through a network hub. Refer to the table below for the LAN port LED indications.
4. **Gigabit LAN2 (RJ-45) port.** This ports allow Gigabit connection to a Local Area Network (LAN) through a network hub. Refer to the table below for the LAN port LED indications.
5. **VGA port.** This port is for a VGA monitor or other VGA-compatible devices.
6. **Serial (COM1) port.** This 9-pin communication port is for pointing devices or other serial devices.
7. **USB 2.0 ports 1 and 2.** These two 4-pin Universal Serial Bus (USB) ports are available for connecting USB 2.0 devices.
8. **PS/2 keyboard port (purple).** This port is for a PS/2 keyboard.

LAN port LED indications

ACT/LINK LED		SPEED LED	
Status	Description	Status	Description
OFF	No link	OFF	10 Mbps connection
GREEN	Linked	ORANGE	100 Mbps connection
BLINKING	Data activity	GREEN	1 Gbps connection

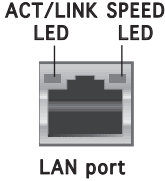

2.7.2 Internal connectors

1. Floppy disk drive connector (34-1 pin FLOPPY1)

This connector is for the provided Floppy Disk Drive (FDD) signal cable. Insert one end of the cable to this connector, then connect the other end to the signal connector at the back of the floppy disk drive.



Pin 5 on the connector is removed to prevent incorrect cable connection when using a FDD cable with a covered Pin 5.

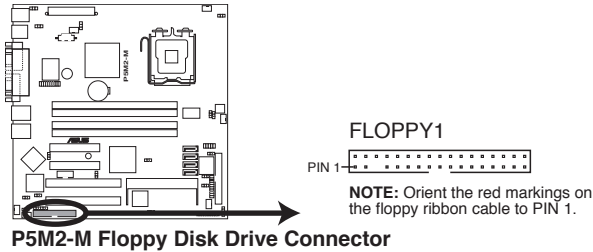

2. ICH7R primary IDE connector (40-1 pin PRI_IDE1)

This connector is for an Ultra DMA 100/66 signal cable. The Ultra DMA 100/66 signal cable has three connectors: a blue connector for the primary IDE connector on the motherboard, a black connector for an Ultra DMA 100/66 IDE slave device (optical drive/hard disk drive), and a gray connector for an Ultra DMA 100/66 IDE master device (hard disk drive). If you install two hard disk drives, you must configure the second drive as a slave device by setting its jumper accordingly. Refer to the hard disk documentation for the jumper settings.



- Pin 20 on the IDE connector is removed to match the covered hole on the Ultra DMA cable connector. This prevents incorrect insertion when you connect the IDE cable.
- Use the 80-conductor IDE cable for Ultra DMA 100/66 IDE devices.

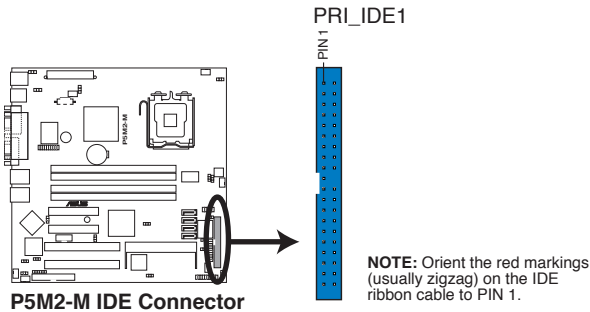

3. Serial ATA connectors (7-pin SATA1, SATA2, SATA3, SATA4)

These connectors are for the Serial ATA signal cables for Serial ATA hard disk drives.

If you installed Serial ATA hard disk drives, you can create a RAID 0, RAID 1, RAID 0+1, and RAID 5 configuration using the Intel® Matrix Storage Technology or RAID 0, RAID 1 and RAID 0+1 configuration using the LSI MegaRAID® utility embedded in the Intel® ICH7R Southbridge.



These connectors are set **IDE** mode by default. In **IDE** mode, you can connect Serial ATA boot/data hard disk drives to these connectors. If you intend to create a Serial ATA RAID set using these connectors, set the **Configure SATA as** item in the BIOS to [RAID]. See section “4.3.4 IDE Configuration” for details.

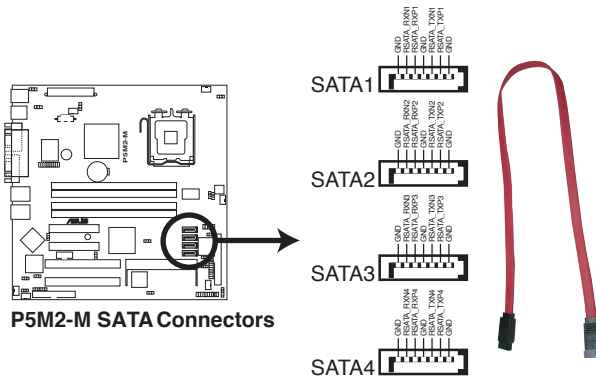

P5M2-M SATA Connectors



Important notes on Serial ATA

- Use only two Serial ATA RAID connectors for each RAID 0 or RAID 1 set.
- When using the connectors in **IDE** mode, connect the primary (boot) hard disk drive to the SATA1 or SATA2 connector. Refer to the table below for the recommended SATA hard disk drive connections.

Serial ATA hard disk drive connection

Connector	Setting	Use
SATA1/SATA2	Master	Boot disk
SATA3/SATA4	Slave	Data disk

4. Hard disk activity LED connector (4-pin HDLED1)

This connector supplies power to the hard disk activity LED. The read or write activities of any device connected to the SCSI connectors or the SATA connectors cause this LED to light up.

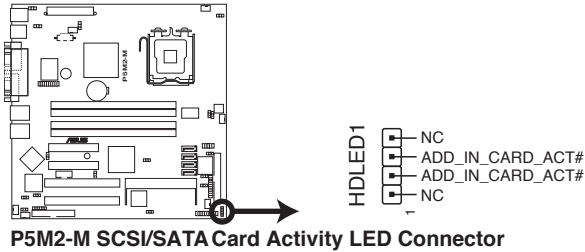

5. USB connector (10-1 pin USB34)

This connector is for USB 2.0 ports. Connect the USB module cable to this connector, then install the module to a slot opening at the back of the system chassis. This USB connector complies with USB 2.0 specification that supports up to 480 Mbps connection speed.

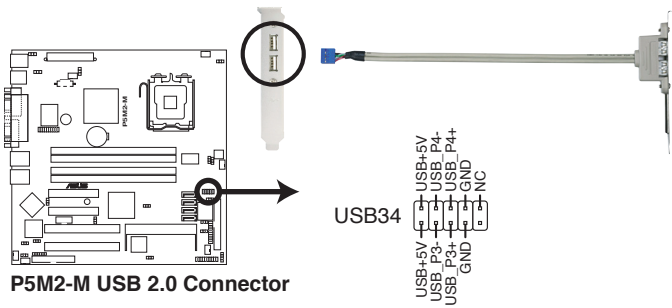

The USB port module is purchased separately.

6. Serial port connector (10-1 pin COM2)

This connector is for a serial (COM) port. Connect the serial port module cable to this connector, then install the module to a slot opening at the back of the system chassis. The serial port module is purchased separately.

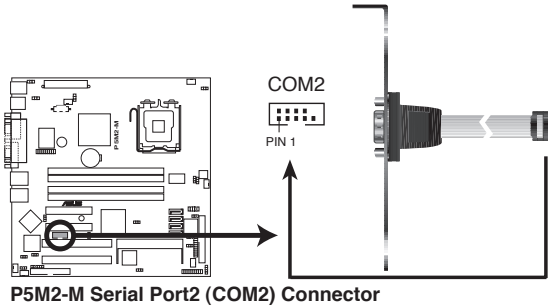

P5M2-M Serial Port2 (COM2) Connector

7. CPU and system fan connectors (3-pin CPU_FAN1/2, REAR_FAN1/2, FRNT_FAN1/2)

The fan connectors support cooling fans of 350 mA ~ 740 mA (8.88 W max.) or a total of 2.1 A ~ 4.44 A (53.28 W max.) at +12V. Connect the fan cables to the fan connectors on the motherboard, making sure that the black wire of each cable matches the ground pin of the connector.



Do not forget to connect the fan cables to the fan connectors. Insufficient air flow inside the system may damage the motherboard components. These are not jumpers! Do not place jumper caps on the fan connectors!

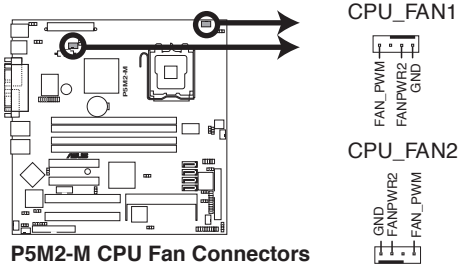

P5M2-M CPU Fan Connectors

8. Backplane SMBus connector (6-1 pin BPSMB1)

This connector allows you to connect SMBus (System Management Bus) devices. Devices communicate with an SMBus host and/or other SMBus devices using the SMBus interface.

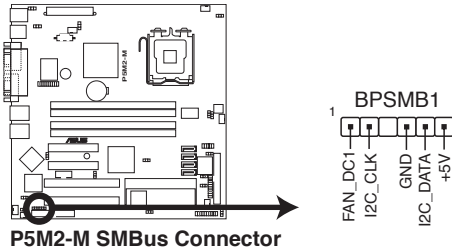

P5M2-M SMBus Connector

9. Power supply SMBus connector (5-pin PSUSMB1)

This connector is for the power supply SMB cable, if your power supply supports the SMBus function.

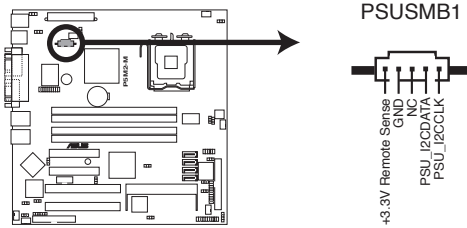

P5M2-M Power Supply SMBus Connector

10. SSI power connectors (24-pin ATXPWR1, 8-pin ATX12V2)

These connectors are for SSI power supply plugs. The power supply plugs are designed to fit these connectors in only one orientation. Find the proper orientation and push down firmly until the connectors completely fit.



- Use of an SSI 12 V Specification 2.0-compliant power supply unit (PSU) that provides a minimum power of 450 W is recommended for a fully-configured system.
- By default, four ATX12V2 connector pins are covered to prevent incorrect insertion of a 4-pin ATX +12V power plug. Remove this cover when using a PSU with an 8-pin ATX +12V power plug.
- Do not forget to connect the 4-pin or 8-pin ATX +12 V power plug; otherwise, the system will not boot up.
- We recommend that you use a PSU with a higher power output when configuring a system with more power consuming devices. The system may become unstable or may not boot up if the power is inadequate.
- You must install a PSU with a higher power rating if you intend to install additional devices.

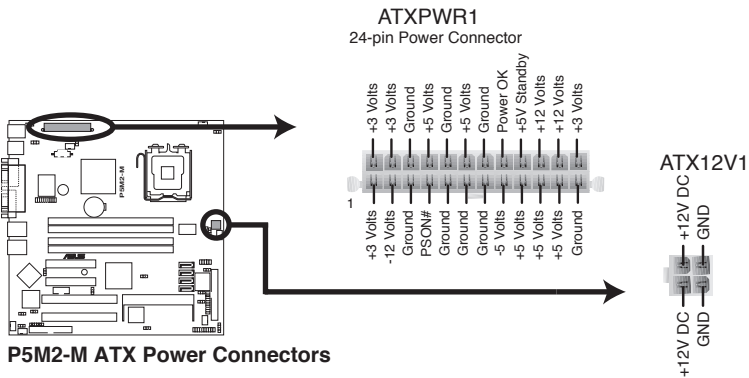

11. Auxiliary panel connector (20-pin AUX_PANEL1)

This connector is for additional front panel features including front panel SMB, locator LED and switch, chassis intrusion, and LAN LEDs.

- **Front panel SMB (6-1 pin FPSMB)**
These leads connect the front panel SMBus cable.
- **LAN activity LED (2-pin LAN1_LED, LAN2_LED)**
These leads are for Gigabit LAN activity LEDs on the front panel.
- **Chassis intrusion (2-pin CHASSIS)**
These leads are for the intrusion detection feature for chassis with intrusion sensor or microswitch. When you remove any chassis component, the sensor triggers and sends a high-level signal to these leads to record a chassis intrusion event.
- **Locator LED (6-pin LOCATOR)**
These leads are for the locator switch and LED on the front panel.

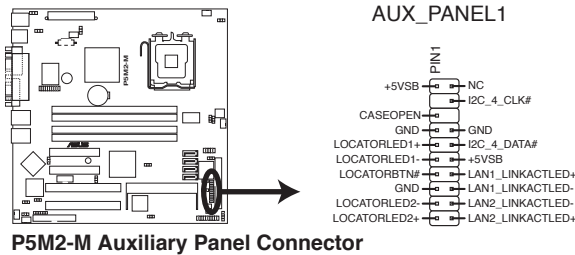

12. System panel connector (20-pin PANEL1)

This connector supports several chassis-mounted functions.

- **System power LED (Green 3-pin PLED)**
This 3-pin connector is for the system power LED. Connect the chassis power LED cable to this connector. The system power LED lights up when you turn on the system power, and blinks when the system is in sleep mode.
- **Message LED (Brown 2-pin MLED)**
This connector is for the message LED cable that connects to the front message LED. The message LED indicates the booting status. The LED blinks when the system is in the boot process until the operating system is loaded.
- **Hard disk drive activity LED (Red 2-pin IDE_LED)**
This 2-pin connector is for the HDD Activity LED. Connect the HDD Activity LED cable to this connector. The IDE LED lights up or flashes when data is read from or written to the HDD.
- **System warning speaker (Orange 4-pin SPEAKER)**
This 4-pin connector is for the chassis-mounted system warning speaker. The speaker allows you to hear system beeps and warnings.
- **ATX power button/soft-off button (Light Green 2-pin PWRSW)**
This connector is for the system power button. Pressing the power button turns the system on or puts the system in sleep or soft-off mode depending on the BIOS settings. Pressing the power switch for more than four seconds while the system is ON turns the system OFF.
- **Reset button (Blue 2-pin RESET)**
This 2-pin connector is for the chassis-mounted reset button for system reboot without turning off the system power.

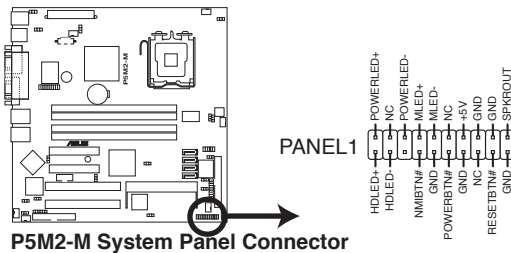

The system panel connector is color-coded for easy connection.

This chapter describes the power up sequence, the vocal POST messages, and ways of shutting down the system.

Powering up **3**

Chapter summary

3

- 3.1 Starting up for the first time 3-1
- 3.2 Powering off the computer..... 3-2

3.1 Starting up for the first time

1. After making all the connections, replace the system case cover.
2. Be sure that all switches are off.
3. Connect the power cord to the power connector at the back of the system chassis.
4. Connect the power cord to a power outlet that is equipped with a surge protector.
5. Turn on the devices in the following order:
 - a. Monitor
 - b. External SCSI devices (starting with the last device on the chain)
 - c. System power
6. After applying power, the system power LED on the system front panel case lights up. For systems with ATX power supplies, the system LED lights up when you press the ATX power button. If your monitor complies with “green” standards or if it has a “power standby” feature, the monitor LED may light up or switch between orange and green after the system LED turns on.

The system then runs the Power-On Self-Test (POST). While the tests are running, the BIOS beeps or additional messages appear on the screen. If you do not see anything within 30 seconds from the time you turned on the power, the system may have failed a power-on test. Check the jumper settings and connections or call your retailer for assistance.

AMI BIOS beep codes

Beep Description	Error
One beep	Keyboard controller error Refresh Time error No master drive detected
Two continuous beeps followed by two short beeps	Floppy controller failure
Two continuous beeps followed by four short beeps	Hardware component failure

7. At power on, hold down the key to enter the BIOS Setup. Follow the instructions in Chapter 4.

3.2 Powering off the computer

3.2.1 Using the OS shut down function

If you are using Windows® Server 2000:

1. Click the **Start** button then click **Shut Down...**
2. Make sure that the **Shut Down** option button is selected, then click the **OK** button to shut down the computer.
3. The power supply should turn off after Windows® shuts down.

If you are using Windows® Server 2003:

1. Click the **Start** button then select **Turn Off Computer**.
2. Click the **Turn Off** button to shut down the computer.
3. The power supply should turn off after Windows® shuts down

3.2.2 Using the dual function power switch

While the system is ON, pressing the power switch for less than four seconds puts the system to sleep mode or to soft-off mode, depending on the BIOS setting. Pressing the power switch for more than four seconds lets the system enter the soft-off mode regardless of the BIOS setting. Refer to section “4.5 Power Menu” in Chapter 4 for details

This chapter tells how to change the system settings through the BIOS Setup menus. Detailed descriptions of the BIOS parameters are also provided.

BIOS setup 4

4.1	Managing and updating your BIOS	4-1
4.2	BIOS setup program.....	4-10
4.3	Main menu.....	4-13
4.4	Advanced menu	4-18
4.5	Power Configuration.....	4-27
4.6	Boot menu	4-31
4.7	Exit menu.....	4-36

4.1 Managing and updating your BIOS

The following utilities allow you to manage and update the motherboard Basic Input/Output System (BIOS) setup.

1. **ASUS AFUDOS** (Updates the BIOS in DOS mode using a bootable floppy disk.)
2. **ASUS CrashFree BIOS 2** (Updates the BIOS using a bootable floppy disk or the motherboard support CD when the BIOS file fails or gets corrupted.)
3. **ASUS Update** (Updates the BIOS in Windows® environment.)

Refer to the corresponding sections for details on these utilities.



Save a copy of the original motherboard BIOS file to a bootable floppy disk in case you need to restore the BIOS in the future. Copy the original motherboard BIOS using the ASUS Update or AFUDOS utilities.

4.1.1 Creating a bootable floppy disk

To create a bootable floppy disk:

DOS environment

- a. Insert a 1.44MB floppy disk into the drive.
- b. At the DOS prompt, type `format A: /s` then press <Enter>.

4.1.2 AFUDOS utility

The AFUDOS utility allows you to update the BIOS file in DOS environment using a bootable floppy disk with the updated BIOS file. This utility also allows you to copy the current BIOS file that you can use as backup when the BIOS fails or gets corrupted during the updating process.

Copying the current BIOS

To copy the current BIOS file using the AFUDOS utility:



- Make sure that the floppy disk is not write-protected and has at least 1024 KB free space to save the file.
- The succeeding BIOS screens are for reference only. The actual BIOS screen displays may not be same as shown.

1. Copy the AFUDOS utility (afudos.exe) from the motherboard support CD to the bootable floppy disk you created earlier.
2. Boot the system in DOS mode, then at the prompt type:

```
afudos /o[filename]
```

where the [filename] is any user-assigned filename not more than eight alphanumeric characters for the main filename and three alphanumeric characters for the extension name.

```
A:\>afudos /oOLDBIOS1.rom
```

Main filename Extension name

3. Press <Enter>. The utility copies the current BIOS file to the floppy disk.

```
A:\>afudos /oOLDBIOS1.rom
AMI Firmware Update Utility - Version 1.19(ASUS V2.07(03.11.24BB))
Copyright (C) 2002 American Megatrends, Inc. All rights reserved.
  Reading flash ..... done
  Write to file..... ok
A:\>
```

The utility returns to the DOS prompt after copying the current BIOS file.

Updating the BIOS file

To update the BIOS file using the AFUDOS utility:

1. Visit the ASUS website (www.asus.com) and download the latest BIOS file for the motherboard. Save the BIOS file to a bootable floppy disk.



Write the BIOS filename on a piece of paper. You need to type the exact BIOS filename at the DOS prompt.

2. Copy the AFUDOS utility (afudos.exe) from the motherboard support CD to the bootable floppy disk you created earlier.
3. Boot the system in DOS mode, then at the prompt type:

```
afudos /i[filename]
```

where [filename] is the latest or the original BIOS file on the bootable floppy disk.

```
A:\>afudos /iP5M2-M.ROM
```

4. The utility verifies the file and starts updating the BIOS.

```
A:\>afudos /iP5M2-M.ROM
AMI Firmware Update Utility - Version 1.19(ASUS V2.07(03.11.24BB))
Copyright (C) 2002 American Megatrends, Inc. All rights reserved.

WARNING!! Do not turn off power during flash BIOS
Reading file ..... done
Reading flash ..... done

Advance Check .....
Erasing flash ..... done
Writing flash ..... 0x0008CC00 (9%)
```



Do not shut down or reset the system while updating the BIOS to prevent system boot failure!

5. The utility returns to the DOS prompt after the BIOS update process is completed. Reboot the system from the hard disk drive.

```
A:\>afudos /iP5M2-M.ROM
AMI Firmware Update Utility - Version 1.19(ASUS V2.07(03.11.24BB))
Copyright (C) 2002 American Megatrends, Inc. All rights reserved.

WARNING!! Do not turn off power during flash BIOS
Reading file ..... done
Reading flash ..... done

Advance Check .....
Erasing flash ..... done
Writing flash ..... done
Verifying flash .... done

Please restart your computer

A:\>
```

Updating the BIOS file using a USB flash drive

If you have not purchased a USB floppy disk drive, you may update the BIOS file using a USB flash drive. Format the USB flash drive to FAT16 or 32 system file before updating the BIOS.

To format the USB flash drive to a FAT32/16 system file:

1. Insert the USB flash drive to an available USB port.
2. From the Windows desktop, click **Start**, then select **My computer**.
3. Right-click the USB flash drive icon, then select **Format** from the menu.
4. From the **File system** field, select **FAT32** or **FAT16**, then click the **Start** button.

To update the BIOS file:

1. Copy the original or the latest BIOS file and the AFUDOS utility (afudos.exe) to the USB flash drive.
2. Insert the USB flash drive to an available USB port, then place the motherboard support CD to the optical drive.
3. Boot the system from the support CD, then select the **FreeDOS command prompt**.
4. At the DOS prompt, replace the prompt with the USB flash disk drive letter, then type: `afudos /i[filename]`
5. Follow the instructions in the previous section to update the BIOS file.

4.1.3 ASUS CrashFree BIOS 2 utility

The ASUS CrashFree BIOS 2 is an auto recovery tool that allows you to restore the BIOS file when it fails or gets corrupted during the updating process. You can update a corrupted BIOS file using the motherboard support CD or the floppy disk that contains the updated BIOS file.



- Prepare the motherboard support CD or the floppy disk containing the updated motherboard BIOS before using this utility.
- Make sure that you rename the original or updated BIOS file in the floppy disk to **P5M2-M.ROM**.

Recovering the BIOS from a floppy disk

To recover the BIOS from a floppy disk:

1. Turn on the system.
2. Insert the floppy disk with the original or updated BIOS file to the floppy disk drive.
3. The utility displays the following message and automatically checks the floppy disk for the original or updated BIOS file.

```
Bad BIOS checksum. Starting BIOS recovery...  
Checking for floppy...
```

When found, the utility reads the BIOS file and starts flashing the corrupted BIOS file.

```
Bad BIOS checksum. Starting BIOS recovery...  
Checking for floppy...  
Floppy found!  
Reading file "P5M2-M.ROM". Completed.  
Start flashing...
```



DO NOT shut down or reset the system while updating the BIOS! Doing so can cause system boot failure!

4. Restart the system after the utility completes the updating process.

Recovering the BIOS from the support CD

To recover the BIOS from the support CD:

1. Remove any floppy disk from the floppy disk drive, then turn on the system.
2. Insert the support CD to the optical drive.
3. The utility displays the following message and automatically checks the floppy disk for the original or updated BIOS file.

```
Bad BIOS checksum. Starting BIOS recovery...  
Checking for floppy...
```

When no floppy disk is found, the utility automatically checks the optical drive for the original or updated BIOS file. The utility then updates the corrupted BIOS file.

```
Bad BIOS checksum. Starting BIOS recovery...  
Checking for floppy...  
Floppy not found!  
Checking for CD-ROM...  
CD-ROM found!  
Reading file "P5M2-M.ROM". Completed.  
Start flashing...
```



DO NOT shut down or reset the system while updating the BIOS! Doing so can cause system boot failure!

4. Restart the system after the utility completes the updating process.



The recovered BIOS may not be the latest BIOS version for this motherboard. Visit the ASUS website (www.asus.com) to download the latest BIOS file.

4.1.4 ASUS Update utility

The ASUS Update is a utility that allows you to manage, save, and update the motherboard BIOS in Windows® environment. The ASUS Update utility allows you to:

- Save the current BIOS file
- Download the latest BIOS file from the Internet
- Update the BIOS from an updated BIOS file
- Update the BIOS directly from the Internet, and
- View the BIOS version information.

This utility is available in the support CD that comes with the motherboard package.



ASUS Update requires an Internet connection either through a network or an Internet Service Provider (ISP).

Installing ASUS Update

To install ASUS Update:

1. Place the support CD in the optical drive. The **Drivers** menu appears.
2. Click the **Utilities** tab, then click **Install ASUS Update VX.XX.XX**.
3. The ASUS Update utility is copied to your system.



Quit all Microsoft® Windows® applications before you update the BIOS using this utility.

Updating the BIOS through the Internet

To update the BIOS through the Internet:

1. Launch the ASUS Update utility from the Windows® desktop by clicking **Start > Programs > ASUS > ASUSUpdate > ASUSUpdate**. The ASUS Update main window appears.

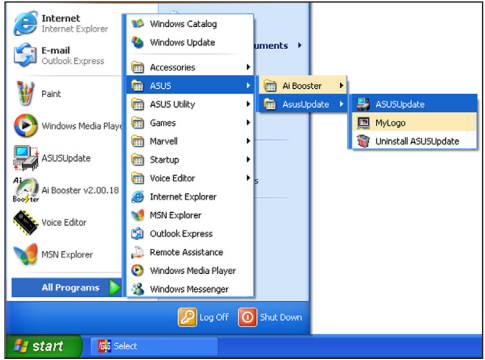

2. Select **Update BIOS from the Internet** option from the drop-down menu, then click **Next**.
3. Select the ASUS FTP site nearest you to avoid network traffic, or click **Auto Select**. Click **Next**.

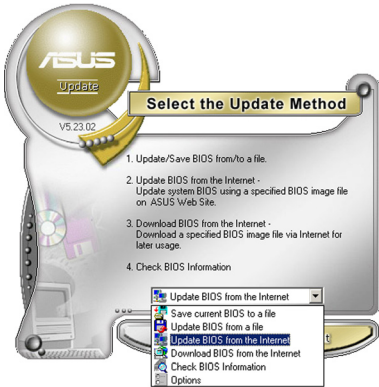

- From the FTP site, select the BIOS version that you wish to download. Click **Next**.
- Follow the screen instructions to complete the update process.



The ASUS Update utility is capable of updating itself through the Internet. Always update the utility to avail all its features.

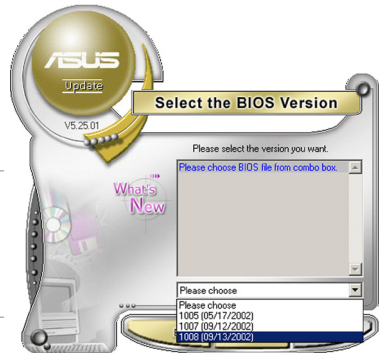

Updating the BIOS through a BIOS file

To update the BIOS through a BIOS file:

- Launch the ASUS Update utility from the Windows® desktop by clicking **Start > Programs > ASUS > ASUSUpdate > ASUSUpdate**. The ASUS Update main window appears.
- Select **Update BIOS from a file** option from the drop-down menu, then click **Next**.

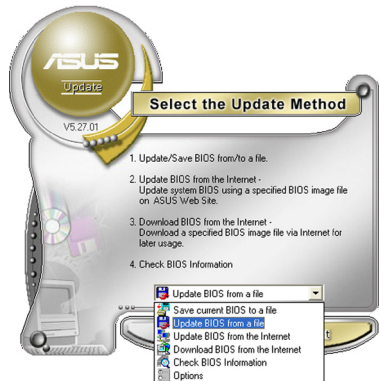

- Locate the BIOS file from the **Open** window, then click **Save**.
- Follow the screen instructions to complete the update process.

4.2 BIOS setup program

This motherboard supports a programmable firmware chip that you can update using the provided utility described in section “4.1 Managing and updating your BIOS”.

Use the BIOS Setup program when you are installing a motherboard, reconfiguring your system, or prompted to “Run Setup”. This section explains how to configure your system using this utility.

Even if you are not prompted to use the Setup program, you can change the configuration of your computer in the future. For example, you can enable the security password feature or change the power management settings. This requires you to reconfigure your system using the BIOS Setup program so that the computer can recognize these changes and record them in the CMOS RAM of the firmware hub.

The firmware hub on the motherboard stores the Setup utility. When you start up the computer, the system provides you with the opportunity to run this program. Press <Delete> during the Power-On Self-Test (POST) to enter the Setup utility; otherwise, POST continues with its test routines.

If you wish to enter Setup after POST, restart the system by pressing <Ctrl> + <Alt> + <Delete>, or by pressing the reset button on the system chassis. You can also restart by turning the system off and then back on. Do this last option only if the first two failed.

The Setup program is designed to make it as easy to use as possible. Being a menu-driven program, it lets you scroll through the various sub-menus and make your selections from the available options using the navigation keys.



-
- The default BIOS settings for this motherboard apply for most conditions to ensure optimum performance. If the system becomes unstable after changing any BIOS settings, load the default settings to ensure system compatibility and stability. Select the **Load Setup Defaults** item under the Exit Menu. See section “4.8 Exit Menu.”
 - The BIOS setup screens shown in this section are for reference purposes only, and may not exactly match what you see on your screen.
 - Visit the ASUS website (www.asus.com) to download the latest BIOS file for this motherboard.
-

4.2.1 BIOS menu screen

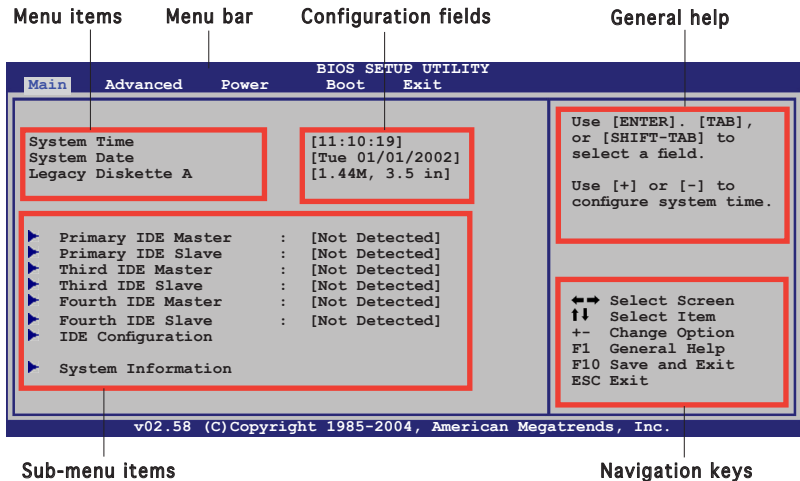

4.2.2 Menu bar

The menu bar on top of the screen has the following main items:

- Main** For changing the basic system configuration
- Advanced** For changing the advanced system settings
- Power** For changing the Advanced Power Management (APM) configuration
- Boot** For changing the system boot configuration
- Exit** For selecting the exit options and loading default settings

To select an item on the menu bar, press the right or left arrow key on the keyboard until the desired item is highlighted.

4.2.3 Navigation keys

At the bottom right corner of a menu screen are the navigation keys for that particular menu. Use the navigation keys to select items in the menu and change the settings.



Some of the navigation keys differ from one screen to another.

4.2.4 Menu items

The highlighted item on the menu bar displays the specific items for that menu. For example, selecting **Main** shows the Main menu items.

The other items (Advanced, Power, Boot, and Exit) on the menu bar have their respective menu items.

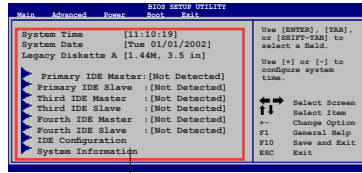

Main menu items

4.2.5 Sub-menu items

A solid triangle before each item on any menu screen means that the item has a sub-menu. To display the sub-menu, select the item and press <Enter>.

4.2.6 Configuration fields

These fields show the values for the menu items. If an item is user-configurable, you can change the value of the field opposite the item. You cannot select an item that is not user-configurable.

A configurable field is enclosed in brackets, and is highlighted when selected. To change the value of a field, select it then press <Enter> to display a list of options. Refer to “4.2.7 Pop-up window.”

4.2.7 Pop-up window

Select a menu item then press <Enter> to display a pop-up window with the configuration options for that item.

4.2.8 Scroll bar

A scroll bar appears on the right side of a menu screen when there are items that do not fit on the screen. Press the Up/Down arrow keys or <Page Up> /<Page Down> keys to display the other items on the screen.

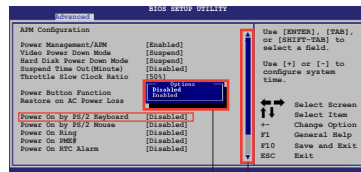

Pop-up window

Scroll bar

4.2.9 General help

At the top right corner of the menu screen is a brief description of the selected item.

4.3 Main menu

When you enter the BIOS Setup program, the **Main** menu screen appears, giving you an overview of the basic system information.



Refer to section “4.2.1 BIOS menu screen” for information on the menu screen items and how to navigate through them.

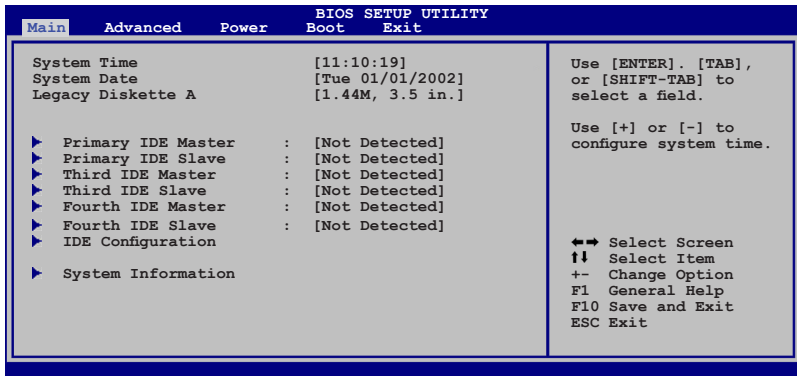

4.3.1 System Time [xx:xx:xx]

Allows you to set the system time.

4.3.2 System Date [Day xx/xx/xxxx]

Allows you to set the system date.

4.3.3 Legacy Diskette A [1.44M, 3.5 in.]

Sets the type of floppy drive installed. Configuration options: [Disabled]
[360K, 5.25 in.] [1.2M , 5.25 in.] [720K , 3.5 in.] [1.44M, 3.5 in.]
[2.88M, 3.5 in.]

4.3.4 Primary, Third, Fourth IDE Master/Slave

The BIOS automatically detects the connected IDE devices. There is a separate sub-menu for each IDE device. Select a device item, then press <Enter> to display the IDE device information.

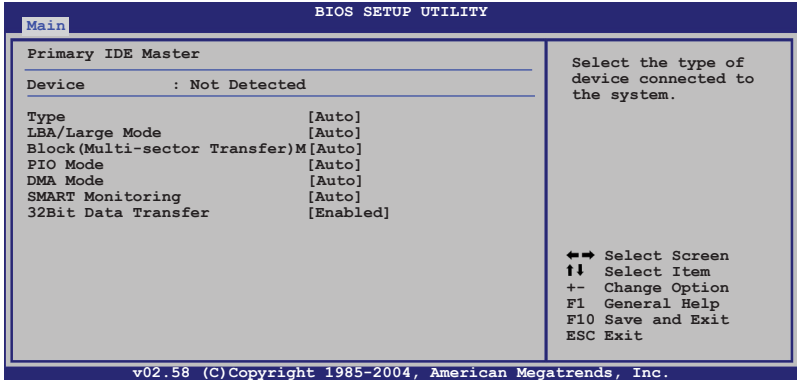

The BIOS automatically detects the values opposite the dimmed items (Device, Vendor, Size, LBA Mode, Block Mode, PIO Mode, Async DMA, Ultra DMA, and SMART monitoring). These values are not user-configurable. These items show N/A if no IDE device is installed in the system.

Type [Auto]

Selects the type of IDE drive. Setting to [Auto] allows automatic selection of the appropriate IDE device type. Select [CDROM] if you are specifically configuring a CD-ROM drive. Select [ARMD] (ATAPI Removable Media Device) if your device is either a ZIP, LS-120, or MO drive. Configuration options: [Not Installed] [Auto] [CDROM] [ARMD]

LBA/Large Mode [Auto]

Enables or disables the LBA mode. Setting to [Auto] enables the LBA mode if the device supports this mode, and if the device was not previously formatted with LBA mode disabled. Configuration options: [Disabled] [Auto]

Block (Multi-sector Transfer) [Auto]

Enables or disables data multi-sectors transfers. When set to [Auto], the data transfer from and to the device occurs multiple sectors at a time if the device supports multi-sector transfer feature. When set to [Disabled], the data transfer from and to the device occurs one sector at a time. Configuration options: [Disabled] [Auto]

PIO Mode [Auto]

Selects the PIO mode. Configuration options: [Auto] [0] [1] [2] [3] [4]

DMA Mode [Auto]

Selects the DMA mode. Configuration options: [Auto] [SWDMA0] [SWDMA1] [SWDMA2] [MWDMA0] [MWDMA1] [MWDMA2] [UDMA0] [UDMA1] [UDMA2]

SMART Monitoring [Auto]

Sets the Smart Monitoring, Analysis, and Reporting Technology. Configuration options: [Auto] [Disabled] [Enabled]

32Bit Data Transfer [Enabled]

Enables or disables 32-bit data transfer. Configuration options: [Disabled] [Enabled]

4.3.5 IDE Configuration

The items in this menu allow you to set or change the configurations for the IDE devices installed in the system. Select an item then press <Enter> if you wish to configure the item.

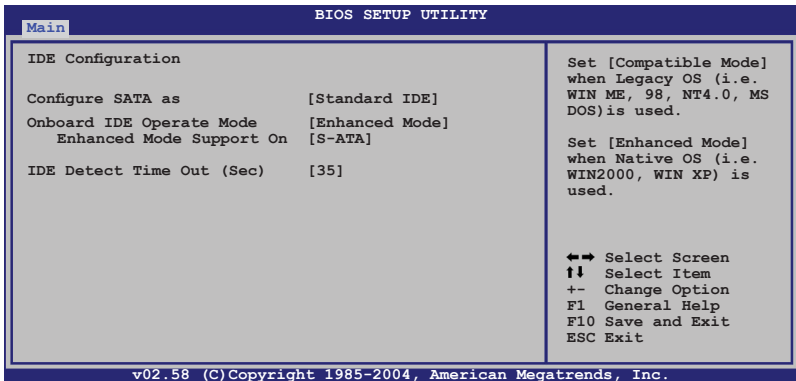

Configure SATA As [Standard IDE]

Sets the configuration for the Serial ATA connectors supported by the Southbridge chip.

If you want to use the Serial ATA hard disk drives as Parallel ATA physical storage devices, set this item to [Standard IDE].

Onboard IDE Operate Mode [Enhanced Mode]

Allows selection of the onboard IDE operation mode depending on the installed operating system (OS). Set to [Enhanced] if you are using native OS, e.g. Windows® 2000/XP. Set to [Compatible] if you are using legacy OS, e.g. Windows ME/98/NT, MS-DOS. Configuration options: [Disabled] [Compatible] [Enhanced]



Set the item **Configure SATA as** to [RAID] if you want to use or configure the SATA connectors under SuSE Linux Enterprise Server 9.0 SP1 operating system environment. Due to the OS limitation, you must set a SATA RAID to use any SATA device (at least two SATA devices are needed for the RAID configuration). Refer to Chapter 5 and Chapter 6 for details on how to set a SATA RAID.

Set **Configure SATA As** to [RAID], if you want to create a RAID 0, RAID 1, RAID 0+1, or RAID 5 configurations using the Intel® Matrix Storage Manager or if you want to create a RAID 0, RAID 1, RAID 0+1 configurations using the LSI Logic Embedded SATA RAID Setup Utility.

OnBoard Serial-ATA BOOTROM [Disabled]

Allows you to enable or disable the Onboard Serial-ATA BOOTROM. Configuration options: [Disabled] [Enabled]

The AHCI allows the onboard storage driver to enable advanced Serial ATA features that enhance storage performance on random workloads by allowing the drive to internally optimize the order of commands.

If you want the Serial ATA hard disk drives to use the Advanced Host Controller Interface (AHCI), set this item to [AHCI]. For details on AHCI, go to: www.intel.com/support/chipsets/imst/sb/CS-012304.htm
www.intel.com/support/chipsets/imst/sb/CS-012305.htm

The SATA controller is set to Native mode when this item is set to [RAID] or [AHCI].

ALPE and ASP [Disabled]

Allows you to enable or disable the Aggressive Link Power Management and Aggressive Slumber/Partial Enabled. Configuration options: [Disabled] [Enabled]

Stagger Spinup Support [Disabled]

Allows you to enable or disable the Stagger Spinup support function. Configuration options: [Disabled] [Enabled]

AHCI Port 3 Interlock Switch [Disabled]

Allows you to enable or disable AHCI Port 3 Interlock Switch. Configuration options: [Disabled] [Enabled]

4.3.6 System Information

This menu gives you an overview of the general system specifications. The BIOS automatically detects the items in this menu.

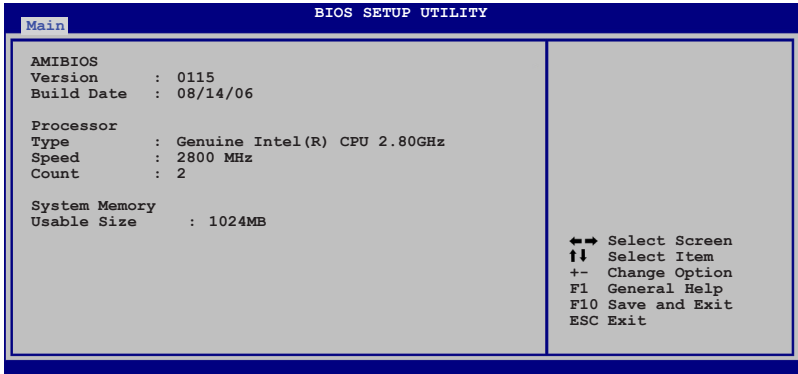

AMI BIOS

Displays the auto-detected BIOS information.

Processor

Displays the auto-detected CPU specification.

System Memory

Displays the auto-detected total system memory.

4.4 Advanced menu

The Advanced menu items allow you to change the settings for the CPU and other system devices.



Take caution when changing the settings of the Advanced menu items. Incorrect field values can cause the system to malfunction.

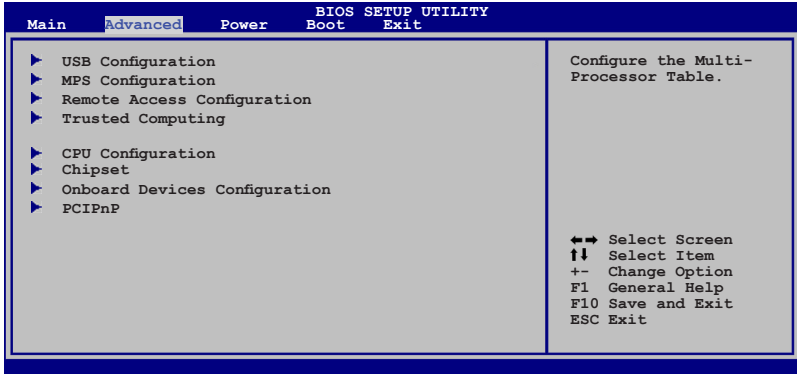

4.4.1 USB Configuration

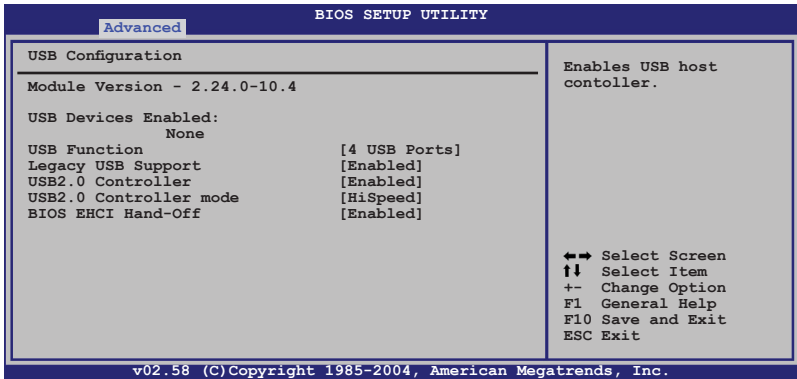

USB Function [4 USB Ports]

Allows you to enable a specific number of USB ports, or disable the USB function. Configuration options: [Disabled] [2 USB Ports] [4 USB Ports]



When USB Function set to 2 USB Ports or 4 USB Ports, the following items appear.

Legacy USB Support [Enabled]

Allows you to enable or disable support for legacy USB. The AUTO option disables legacy support if there is no USB device connected.
Configuration options: [AUTO] [2 USB Ports] [4 USB Ports]

USB 2.0 Controller [Enabled]

Allows you to enable or disable the USB 2.0 controller.
Configuration options: [Enabled] [Disabled]

USB2.0 Controller mode [HiSpeed]

Allows you to select the USB2.0 controller mode.
Configuration options: [HiSpeed] [FullSpeed]

BIOS EHCI Hand-Off [Enabled]

Allows you to enable or disable the BIOS EHCI Hand-Off support function.
Configuration options: [Disabled] [Enabled]

4.4.2 MPS Configuration

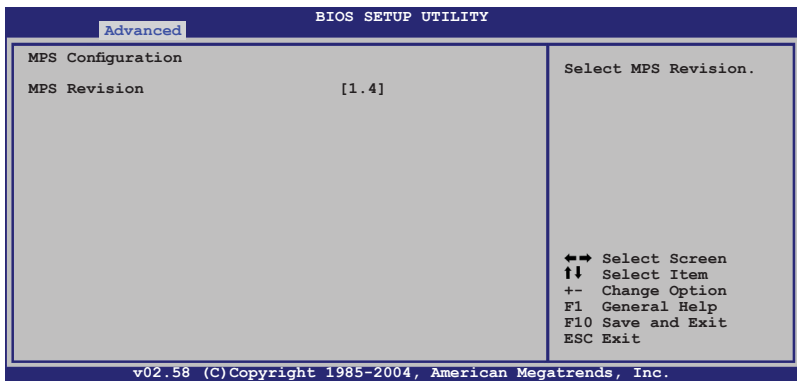

MPS Revision [1.4]

Allows you to select the multi-processor system version.
Configuration options: [1.1] [1.4]

4.4.3 Remote Access Configuration

The items in this menu allows you to configure the Remote Access features. Select an item then press <Enter> to display the configuration options.

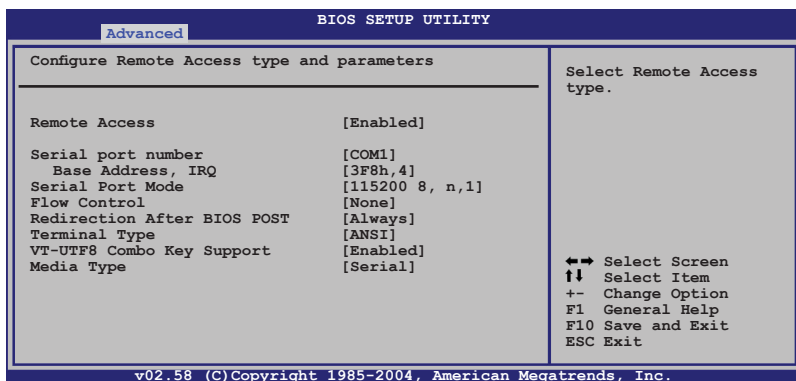

Remote Access [Enabled]

Enables or disables the remote access feature.

Configuration options: [Disabled] [Enabled]



The following items appear only when the **Remote Access** item is set to [Enabled].

Serial port number [COM1]

Allows you to select a serial port for console redirection. Configuration options: [COM1] [COM2]

Serial Port Mode [115200 8, n,1]

Allows you to select a serial port mode. Configuration options: [115200 8,n,1] [57600 8,n,1] [38400 8,n,1] [19200 8,n,1] [09600 8,n,1]

Flow Control [None]

Allows you to set the flow control for console redirection. Configuration options: [None] [Hardware] [Software]

Redirection After BIOS POST [Always]

Sets the redirection mode after the BIOS Power-On Self-Test (POST). Some operating systems may not work when this item is set to Always.

Configuration options: [Disabled] [Boot Loader] [Always]

Terminal Type [ANSI]

Allows you to select the target terminal type. Configuration options: [ANSI] [VT100] [VT-UTF8]

VT-UTF8 Combo Key Support [Enabled]

Allows you to enable or disable VT-UTF8 Combination Key Support for ANSI/VT100 terminals. Configuration options: [Enabled] [Disabled]

Media Type [Serial]

Allows you to select the media for console redirection. Configuration options: [Serial] [LAN] [Serial + LAN]

4.4.4 Trusted Computing

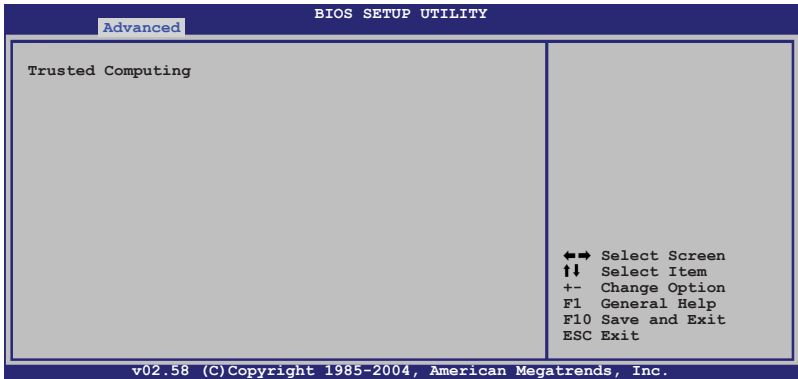

Use this option to configure settings related to trusted computing innovations.



You need to install ASUS TPM card to make this feature function.

4.4.5 CPU Configuration

The items in this menu show the CPU-related information that the BIOS automatically detects.

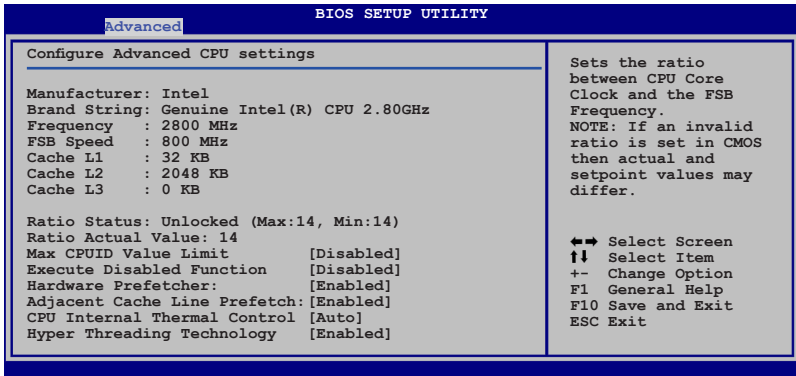

Max CPUID Value Limit [Disabled]

Setting this item to [Enabled] allows legacy operating systems to boot even without support for CPUs with extended CPUID functions.

Configuration options: [Disabled] [Enabled]

Execute Disabled Function [Disabled]

Allows you to enable or disable the Execute Disabled function.

Configuration options: [Disabled] [Enabled]

Hardware Prefetcher: [Enabled]

Allows you to enable or disable the Hardware Prefetch. Configuration options: [Disabled] [Enabled]

Adjacent Cache Line Prefetch:[Enabled]

Allows you to enable or disable the Adjacent Cache Line Prefetch.

Configuration options: [Disabled] [Enabled]

CPU Internal Thermal Control [Auto]

Allows you to set CPU internal thermal control. if set to Auto, BIOS automatically check CPU's capability to enable TM or TM2 support. In TM mode, CPU power consumption is reduced; in TM2 mode, CPU core ratio and VID is reduced. Configuration options: [Auto] [Disabled]



The Hyper-Threading Technology item appears only when you installed an Intel® Pentium® 4 CPU that supports the Hyper-Threading Technology. Hyper-Threading is not supported when you installed a dual-core CPU.

Hyper-Threading Technology [Enabled]

Allows you to enable or disable the processor Hyper-Threading Technology. Configuration options: [Disabled] [Enabled]

4.4.6 Chipset Configuration

The Chipset Configuration menu allows you to change the advanced chipset settings. Select an item then press <Enter> to display the sub-menu.

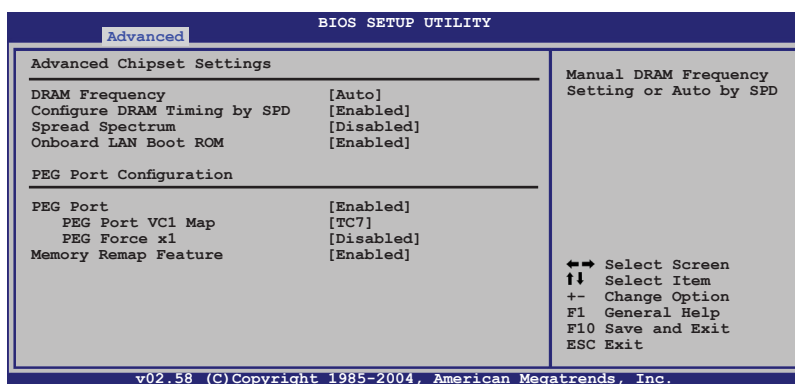

DRAM Frequency [Auto]

Allows you to set the DDR operating frequency. Configuration options: [Auto] [533 MHz] [667 MHz]

Configure DRAM Timing by SPD [Enabled]

When this item is enabled, the DRAM timing parameters are set according to the DRAM SPD (Serial Presence Detect). When disabled, you can manually set the DRAM timing parameters through the DRAM sub-items. The following sub-items appear when this item is disabled.

Configuration options: [Disabled] [Enabled]

DRAM CAS# Latency [5 Clocks]

Controls the latency between the SDRAM read command and the time the data actually becomes available. Configuration options: [5 Clocks] [4 Clocks] [3 Clocks] [6 Clocks]

DRAM RAS# to CAS# Delay [4 Clocks]

Controls the latency between the DDR SDRAM active command and the read/write command. Configuration options: [2 Clocks] [3 Clocks] [4 Clocks] [5 Clocks]

DRAM RAS# Activate to Precharge Delay [15 DRAM Clocks]

Configuration options: [1 Clocks] [2 Clocks] ~ [15 Clocks]

DRAM Write Recovery Time [4 Clocks]

Configuration options: [2 Clocks] [3 Clocks] [4 Clocks] [5 Clocks]

Spread Spectrum [Disabled]

Allows you to enable or disable the spread spectrum. Configuration options: [Disabled] [Enabled]

Onboard LAN Boot ROM [Enabled]

Allows you to enable or disable the option ROM in the onboard LAN controller. Configuration options: [Disabled] [Enabled]

PEG Port Configuration

PEG Port [Auto]

Allows you to set or disable the PCI Express Graphic port. Configuration options: [Auto] [Disabled]

Memory Remap Feature [Enabled]

Allows you to remap the overlap PCI memory over the total physical memory. Configuration options: [Disabled] [Enabled]



Disable this item if you are using RedHat Linux Advanced Server 3.0 UPS/UP6 operating system.

4.4.7 Onboard Devices Configuration

The Onboard Devices Configuration menu allows you to change the onboard devices settings. Select an item then press <Enter> to display the sub-menu.

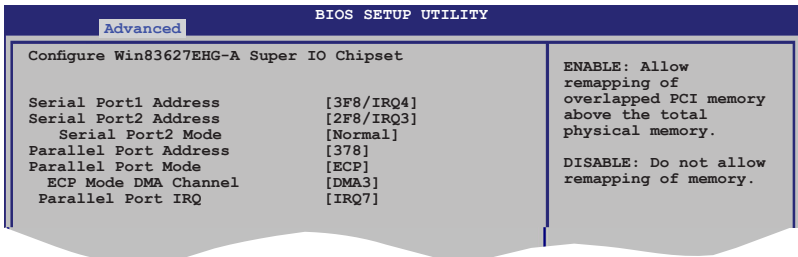

Serial Port1 Address [3F8/IRQ4]

Allows you to select the Serial Port1 base address.

Configuration options: [Disabled] [3F8/IRQ4] [3E8/IRQ4] [2E8/IRQ3]

Serial Port2 Address [2F8/IRQ3]

Allows you to select the Serial Port2 base address.

Configuration options: [Disabled] [2F8/IRQ3] [3E8/IRQ4] [2E8/IRQ3]

Serial Port2 Mode [Normal]

Allows you to select the Serial Port2 mode.

Configuration options: [Normal] [IrDA] [ASK IR]

Parallel Port Address [378]

Allows you to select the Parallel Port base addresses.

Configuration options: [Disabled] [378] [278] [3BC]

Parallel Port Mode [ECP]

Allows you to select the Parallel Port mode.

Configuration options: [Normal] [Bi-directional] [ECP] [EPP]

EPP Version [1.9]

Allows selection of the Parallel Port EPP version. This item appears when the Parallel Port Mode is set to [EPP] or [ECP & EPP].

Configuration options: [1.9] [1.7]

ECP Mode DMA Channel [DMA3]

Appears when the Parallel Port Mode is set to [ECP] or [ECP & EPP].

This item allows you to set the Parallel Port ECP DMA.

Configuration options: [DMA0] [DMA1] [DMA3]

Parallel Port IRQ [IRQ7]

Sets the Parallel port IRQ. Configuration options: [IRQ5] [IRQ7]

4.4.8 PCI PnP

The PCI PnP menu items allow you to change the advanced settings for PCI/PnP devices. The menu includes setting IRQ and DMA channel resources for either PCI/PnP or legacy ISA devices, and setting the memory size block for legacy ISA devices.



Take caution when changing the settings of the PCI PnP menu items. Incorrect field values can cause the system to malfunction.

Advanced		BIOS SETUP UTILITY			
Advanced PCI/PnP Settings					
WARNING: Setting wrong values in below sections may cause system to malfunction.		NO: Lets the BIOS configure all the devices in the system. YES: Lets the operating system configure Plug and Play (PnP) devices not required for boot if your system has a Plug and Play operating system.			
Plug And Play O/S	[No]	← Select Screen ↑↓ Select Item +- Change Option F1 General Help F10 Save and Exit ESC Exit			
PCI Latency Timer	[64]				
Allocate IRQ to PCI VGA	[Yes]				
Palette Snooping	[Disabled]				
IRQ-3 assigned to	[PCI Device]				
IRQ-4 assigned to	[PCI Device]				
IRQ-5 assigned to	[PCI Device]				
IRQ-7 assigned to	[PCI Device]				
IRQ-9 assigned to	[PCI Device]				
IRQ-10 assigned to	[PCI Device]				
IRQ-11 assigned to	[PCI Device]				
IRQ-14 assigned to	[PCI Device]				
IRQ-15 assigned to	[PCI Device]				
				©Copyright 1985-2002, American Megatrends, Inc.	

Plug And Play O/S [No]

When set to [No], BIOS configures all the devices in the system. When set to [Yes] and if you install a Plug and Play operating system, the operating system configures the Plug and Play devices not required for boot. Configuration options: [No] [Yes]

PCI Latency Timer [64]

Allows you to select the value in units of PCI clocks for the PCI device latency timer register. Configuration options: [32] [64] [96] [128] [160] [192] [224] [248]

Allocate IRQ to PCI VGA [Yes]

When set to [Yes], BIOS assigns an IRQ to PCI VGA card if the card requests for an IRQ. When set to [No], BIOS does not assign an IRQ to the PCI VGA card even if requested. Configuration options: [No] [Yes]

Palette Snooping [Disabled]

When set to [Enabled], the palette snooping feature informs the PCI devices that an ISA graphics device is installed in the system so that the latter can function correctly. Configuration options: [Disabled] [Enabled]

IRQ-xx assigned to [PCI Device]

When set to [PCI Device], the specific IRQ is free for use of PCI/PnP devices. When set to [Reserved], the IRQ is reserved for legacy ISA devices. Configuration options: [PCI Device] [Reserved]

4.5 Power Configuration

The Power Configuration menu items allow you to change the settings for the ACPI and Advanced Power Management (APM) features. Select an item then press <Enter> to display the configuration options.

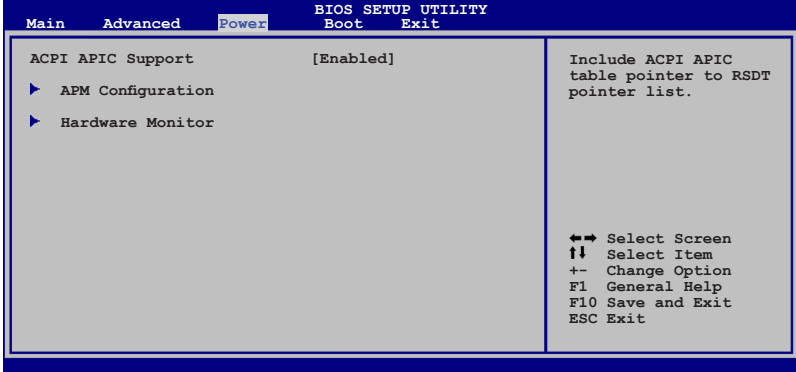

ACPI APIC Support [Enabled]

Allows you to enable or disable the Advanced Configuration and Power Interface (ACPI) support in the Advanced Programmable Interrupt Controller (APIC). When set to Enabled, the ACPI APIC table pointer is included in the RSDT pointer list. Configuration options: [Disabled] [Enabled]

4.5.1 APM Configuration

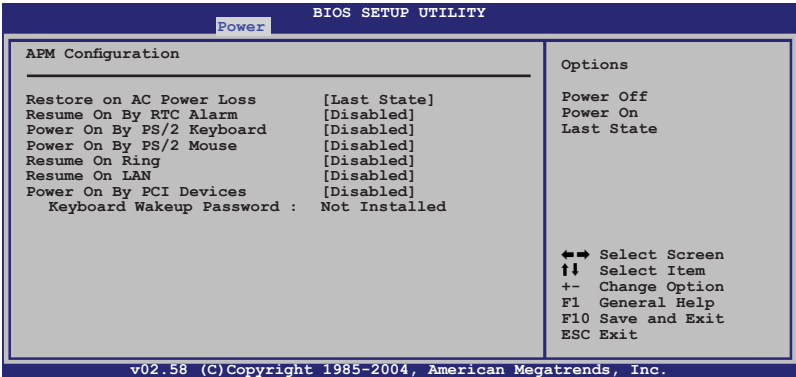

Restore on AC Power Loss [Last State]

When set to Power Off, the system goes into off state after an AC power loss. When set to Power On, the system goes on after an AC power loss. When set to Last State, the system goes into either off or on state,

whatever the system state was before the AC power loss.
Configuration options: [Power Off] [Power On] [Last State]

Resume On By RTC Alarm [Disabled]

Allows you to enable or disable RTC to generate a wake event. When this item is set to [Enabled], the items RTC Alarm Date, RTC Alarm Hour, RTC Alarm Minute, and RTC Alarm Second appear with set values.
Configuration options: [Disabled] [Enabled]



The following items appear only when the **Resume On By RTC Alarm** item is set to Enabled.

RTC Alarm Date (Days) [15]

To set the alarm date, highlight this item and press the <+> or <-> key to make the selection. Configuration options: [Everyday] [1] [2] [3]...[31]

System Time [12:30:30]

To set the alarm time, highlight this item and press the <+> or <-> key to make the selection.

Power On By PS/2 Keyboard [Disabled]

Allows you to use specific keys on the keyboard to turn on the system. This feature requires an ATX power supply that provides at least 1A on the +5VSB lead. Configuration options: [Disabled] [Enabled]

Power On By PS/2 Mouse [Disabled]

When set to [Enabled], this parameter allows you to use the PS/2 mouse to turn on the system. This feature requires an ATX power supply that provides at least 1A on the +5VSB lead. Configuration options: [Disabled] [Enabled]

Resume On Ring [Disabled]

When set to [Enabled], the system enables the RI to generate a wake event while the computer is in Soft-off mode.
Configuration options: [Disabled] [Enabled]

Power on By PCI Devices [Disabled]

When set to [Enabled], this parameter allows you to turn on the system through a PCI LAN or Modem card. This Feature requires an ATX power supply that provides at least 1A on the +5VSB lead.

Configuration options: [Disabled] [Enabled]

4.5.2 Hardware Monitor

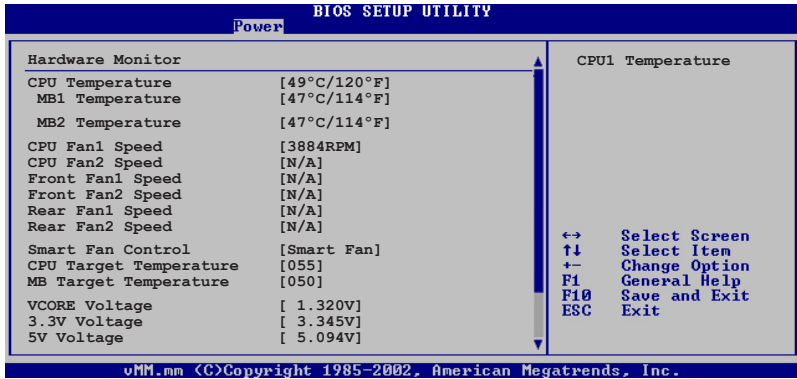

Use the arrow down key to display additional items.



CPU Temperature [xxx°C/xxx°F]

MB1 Temperature [xxx°C/xxx°F]

The onboard hardware monitor automatically detects and displays the motherboard and CPU temperatures. Select [Ignored] if you do not wish to display the detected temperatures.

CPU Fan1/2 Speed [xxxxRPM] or [N/A]

Front Fan1/2 Speed [xxxxRPM] or [N/A]

Rear Fan1/2 Speed [xxxxRPM] or [N/A]

The onboard hardware monitor automatically detects and displays the CPU, front, and rear fan speed in rotations per minute (RPM). If the fan is not connected to the motherboard, the field shows N/A.

Smart Fan Control [Smart Fan]

Allows you to enable or disable the ASUS Smart Fan feature that smartly adjusts the fan speeds for more efficient system operation. Configuration options: [Disabled] [Smart Fan]



The **CPU Temperature** and **MB Temperature** items appear when you set the **Smart Fan Control** item to [Smart Fan].

**CPU Temperature [XXX]
MB1 Temperature [XXX]**

Displays the detected CPU and system threshold temperature when the Smart Fan Control is enabled.

VCORE1 Voltage, VCORE2 Voltage, 3.3V Voltage, 5V Voltage, 5VSB Voltage, VBAT Voltage, 12V Voltage

The onboard hardware monitor automatically detects the voltage outputs through the onboard voltage regulators.

4.6 Boot menu

The Boot menu items allow you to change the system boot options. Select an item then press <Enter> to display the sub-menu.

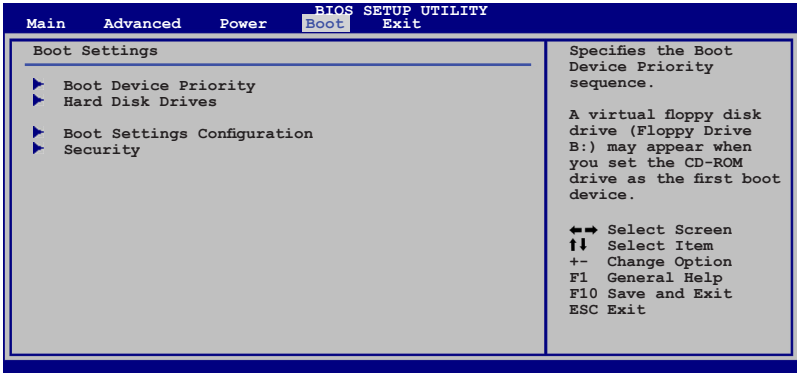

4.6.1 Boot Device Priority

BIOS SETUP UTILITY	
Boot	
Boot Device Priority	
1st Boot Device	[1st FLOPPY Drive]
2nd Boot Device	[Network: MBA v7.7.5]
3rd Boot Device	[Network: MBA v7.7.5]

1st Boot Device [1st FLOPPY Drive]
2nd Boot Device [Network: MBA v7.7.5]
3rd Boot Device [Network: MBA v7.7.5]

These items specify the boot device priority sequence from the available devices. Configuration options: [xxxxx Drive] [Disabled]

4.6.2 Hard Disk Drives

BIOS SETUP UTILITY	
Boot	
Boot Device Priority	
1st Drive	[HDD: XXXXXXXX Drive]
2nd Drive	[HDD: XXXXXXXX Drive]
Specifies the Boot Device Priority sequence from available Hard Drives.	

1st ~ xxth Drive [HDD: XXXXXXXX Drive]

These items specify the boot device priority sequence from the available hard disk drives. The number of device items that appears on the screen depends on the number of devices installed in the system. Configuration options: [xxxxx Drive] [Disabled]

4.6.3 Boot Settings Configuration

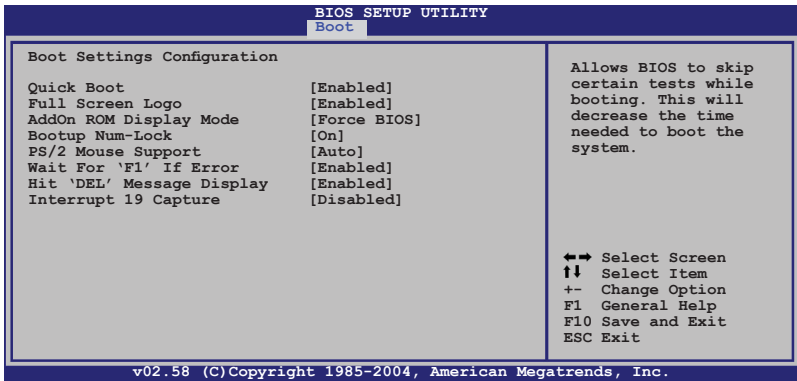

Quick Boot [Enabled]

Enabling this item allows the BIOS to skip some power on self tests (POST) while booting to decrease the time needed to boot the system. When set to [Disabled], BIOS performs all the POST items.
Configuration options: [Disabled] [Enabled]

Full Screen Logo [Enabled]

Allows you to enable or disable the full screen logo display feature.
Configuration options: [Disabled] [Enabled]



Set this item to [Enabled] to use the ASUS MyLogo2™ feature.

AddOn ROM Display Mode [Force BIOS]

Allows you to set display mode for optional ROM. Configuration options: [Force BIOS] [Keep Current]

Bootup Num-Lock [On]

Allows you to select the power-on state for the NumLock.
Configuration options: [Off] [On]

PS/2 Mouse Support [Auto]

Allows you to enable or disable support for PS/2 mouse.
Configuration options: [Disabled] [Enabled] [Auto]

Wait for 'F1' If Error [Enabled]

When set to Enabled, the system waits for the F1 key to be pressed when error occurs. Configuration options: [Disabled] [Enabled]

Hit 'DEL' Message Display [Enabled]

When set to Enabled, the system displays the message "Press DEL to run Setup" during POST. Configuration options: [Disabled] [Enabled]

Interrupt 19 Capture [Disabled]

When set to [Enabled], this function allows the option ROMs to trap Interrupt 19. Configuration options: [Disabled] [Enabled]

4.6.4 Security

The Security menu items allow you to change the system security settings. Select an item then press <Enter> to display the configuration options.



Change Supervisor Password

Select this item to set or change the supervisor password. The Supervisor Password item on top of the screen shows the default **Not Installed**. After you set a password, this item shows **Installed**.

To set a Supervisor Password:

1. Select the **Change Supervisor Password** item, then press <Enter>.
2. From the password box, type a password composed of at least six letters and/or numbers, then press <Enter>.
3. Confirm the password when prompted.

The message "Password Installed" appears after you successfully set your password.

To change the supervisor password, follow the same steps as in setting a user password.

To clear the supervisor password, select the **Change Supervisor Password** then press <Enter>. The message “Password Uninstalled” appears.



If you forget your BIOS password, you can clear it by erasing the CMOS Real Time Clock (RTC) RAM. See section “2.6 Jumpers” for information on how to erase the RTC RAM.

After you have set a supervisor password, the other items appear to allow you to change other security settings.

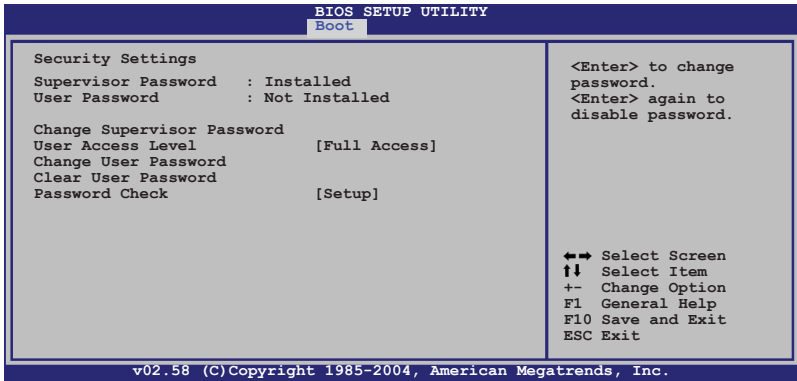

User Access Level [Full Access]

This item allows you to select the access restriction to the Setup items. Configuration options: [No Access] [View Only] [Limited] [Full Access]

No Access prevents user access to the Setup utility.

View Only allows access but does not allow change to any field.

Limited allows changes only to selected fields, such as Date and Time.

Full Access allows viewing and changing all the fields in the Setup utility.

Change User Password

Select this item to set or change the user password. The User Password item on top of the screen shows the default **Not Installed**. After you set a password, this item shows **Installed**.

To set a User Password:

1. Select the **Change User Password** item and press <Enter>.

2. On the password box that appears, type a password composed of at least six letters and/or numbers, then press <Enter>.
3. Confirm the password when prompted.

The message “Password Installed” appears after you set your password successfully.

To change the user password, follow the same steps as in setting a user password.

Clear User Password

Select this item to clear the user password.

Password Check [Setup]

When set to [Setup], BIOS checks for user password when accessing the Setup utility. When set to [Always], BIOS checks for user password both when accessing Setup and booting the system.

Configuration options: [Setup] [Always]

4.7 Exit menu

The Exit menu items allow you to load the optimal or failsafe default values for the BIOS items, and save or discard your changes to the BIOS items.

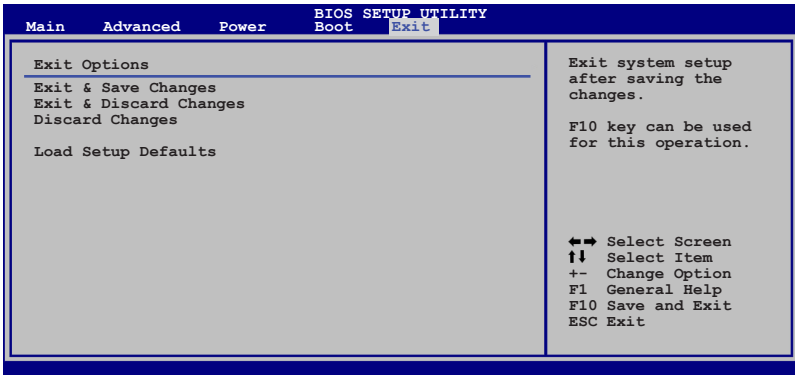

If you made changes to any of the settings in the menus, pressing <Esc> does not immediately exit this menu. A confirmation window appears and prompts you to either save your changes or cancel the command. Select one of the options from this menu to exit.

Exit & Save Changes

Select this option then press <Enter>, or simply press <F10>, to save your changes to CMOS before exiting the Setup utility.

When a confirmation window appears, select [OK] then press <Enter> to save your changes and exit Setup. If you wish to cancel the command, select [Cancel] then press <Enter> to return to the Exit menu.

Exit & Discard Changes

Select this option then press <Enter> to exit the Setup utility without saving your changes.

When a confirmation window appears, select [OK] then press <Enter> to discard your changes and exit Setup. If you wish to cancel the command, select [Cancel] then press <Enter> to return to the Exit menu.

Discard Changes

Select this option then press <Enter> to discard the changes that you made, and restore the previously saved settings.

When a confirmation window appears, select [OK] then press <Enter> to discard the changes, and load the previously saved settings. If you wish to cancel the command, select [Cancel] then press <Enter> to return to the Exit menu.

Load Setup Defaults

Select this option then press <Enter> to load the optimized settings for each of the Setup menu items.

When a confirmation window appears, select [OK] then press <Enter> to load the default settings. If you wish to cancel the command, select [Cancel] then press <Enter> to return to the Exit menu.

This chapter provides instructions for setting up, creating, and configuring RAID sets using the available utilities.

5 RAID configuration

5.1	RAID configurations	5-1
5.2	Intel Matrix Storage Manager option ROM utility	5-3
5.3	LSI Logic Embedded SATA RAID Setup Utility	5-14
5.4	Global Array Manager.....	5-36

5.1 RAID configurations

The server system/motherboard comes with the Intel® ICH7R and the LSI Logic Embedded SATA RAID technology built-in the Intel® ICH7R SouthBridge chipset that allows you to configure IDE and Serial ATA hard disk drives as RAID sets. The motherboard supports the following RAID configurations:

5.1.1 RAID definitions

RAID 0 (*Data striping*) optimizes two identical hard disk drives to read and write data in parallel, interleaved stacks. Two hard disks perform the same work as a single drive but at a sustained data transfer rate, double that of a single disk alone, thus improving data access and storage. Use of two new identical hard disk drives is required for this setup.

RAID 1 (*Data mirroring*) copies and maintains an identical image of data from one drive to a second drive. If one drive fails, the disk array management software directs all applications to the surviving drive as it contains a complete copy of the data in the other drive. This RAID configuration provides data protection and increases fault tolerance to the entire system. Use two new drives or use an existing drive and a new drive for this setup. The new drive must be of the same size or larger than the existing drive.

RAID 5 stripes both data and parity information across three or more hard disk drives. Among the advantages of RAID 5 configuration include better HDD performance, fault tolerance, and higher storage capacity. The RAID 5 configuration is best suited for transaction processing, relational database applications, enterprise resource planning, and other business systems. Use a minimum of three identical hard disk drives for this setup.

RAID 10 is a striped configuration with RAID 1 segments whose segments are RAID 1 arrays. This configuration has the same fault tolerance as RAID 1, and has the same overhead for fault-tolerance as mirroring alone. RAID 10 achieves high input/output rates by striping RAID 1 segments. In some instances, a RAID 10 configuration can sustain multiple simultaneous drive failure. A minimum of four hard disk drives is required for this setup.

Intel® Matrix Storage. The Intel® Matrix Storage technology supported by the ICH7R chip allows you to create a RAID 0 and a RAID 1 set using only two identical hard disk drives. The Intel® Matrix Storage technology creates two partitions on each hard disk drive to create a virtual RAID 0 and RAID 1 sets. This technology also allows you to change the hard disk drive partition size without losing any data.



If you want to boot the system from a hard disk drive included in a created RAID set, copy first the RAID driver from the support CD to a floppy disk before you install an operating system to the selected hard disk drive. Refer to section “6.1 RAID driver installation” for details.

5.1.2 Installing Serial ATA hard disks

The motherboard supports Serial ATA hard disk drives. For optimal performance, install identical drives of the same model and capacity when creating a disk array.

To install the SATA hard disks for a RAID configuration:

1. Install the SATA hard disks into the drive bays.
2. Connect the SATA signal cables.
3. Connect a SATA power cable to the power connector on each drive.

5.1.3 Setting the RAID item in BIOS

You must set the RAID item in the BIOS Setup before you can create a RAID set(s). To do this:

1. Enter the BIOS Setup during POST.
2. Go to the **Main Menu**, select **IDE Configuration**, then press <Enter>.
3. Select the item **Configure SATA As**, then press <Enter> to display the configuration options.
4. Select **RAID** from the Configure SATA As item options, then press <Enter>.
5. Select the item **Onboard Serial-ATA BOOTROM**, press <Enter>, then select **Enabled** from the options.
6. Save your changes, then exit the BIOS Setup.



Refer to Chapter 4 for details on entering and navigating through the BIOS Setup.

5.1.4 RAID configuration utility

Depending on the RAID_SEL1 jumper setting and the operating system, you can select a utility to create a RAID set. Refer to section “2.6 Jumpers” for details on the RAID_SEL1 jumper settings.

Use the Intel® Matrix Storage Manager to create a RAID 0, RAID 1, RAID 0+1, or software RAID 5 under Windows® 2000/2003 Server/XP operating system.

Use the LSI Logic Embedded SATA RAID Setup Utility to create a RAID 0, RAID 1, or RAID 0+1 under Windows® 2000/2003 Server/XP or Red Hat® Enterprise ver. 3.0 operating system.

Refer to the succeeding sections for details on how to use the RAID configuration utilities.

5.2 Intel® Matrix Storage Manager Option ROM Utility

The Intel® Matrix Storage Manager Option ROM utility allows you to create RAID 0, RAID 1, RAID 10 (RAID 0+1), and RAID 5 set(s) from Serial ATA hard disk drives that are connected to the Serial ATA connectors supported by the Southbridge.

To enter the Intel® Application Accelerator RAID Option ROM utility:

1. Install all the Serial ATA hard disk drives.
2. Turn on the system.
3. During POST, press <Ctrl> + <I> to display the utility main menu.

```
Intel(R) Matrix Storage Manager Option ROM v5.0.0.1032 ICH7R wRAID5
Copyright(C) 2003-05 Intel Corporation. All Rights Reserved.

[ MAIN MENU ]
1. Create RAID Volume
2. Delete RAID Volume
3. Reset Disks to Non-RAID
4. Exit

[ DISK/VOLUME INFORMATION ]

RAID Volumes:
None defined.

Physical Disks:
Port Drive Model      Serial #              Size      Type/Status (Vol ID)
0  XXXXXXXXXXXX        XXXXXXXXXXXX         XX.XXGB  Non-RAID Disk
1  XXXXXXXXXXXX        XXXXXXXXXXXX         XX.XXGB  Non-RAID Disk
2  XXXXXXXXXXXX        XXXXXXXXXXXX         XX.XXGB  Non-RAID Disk
3  XXXXXXXXXXXX        XXXXXXXXXXXX         XX.XXGB  Non-RAID Disk

[↑↓]-Select      [ESC]-Exit      [ENTER]-Select Menu
```

The navigation keys at the bottom of the screen allow you to move through the menus and select the menu options.



The RAID BIOS setup screens shown in this section are for reference only and may not exactly match the items on your screen.

5.2.1 Creating a RAID 0 set (striped)

To create a RAID 0 set:

1. From the utility main menu, select **1. Create RAID Volume**, then press <Enter>. This screen appears.

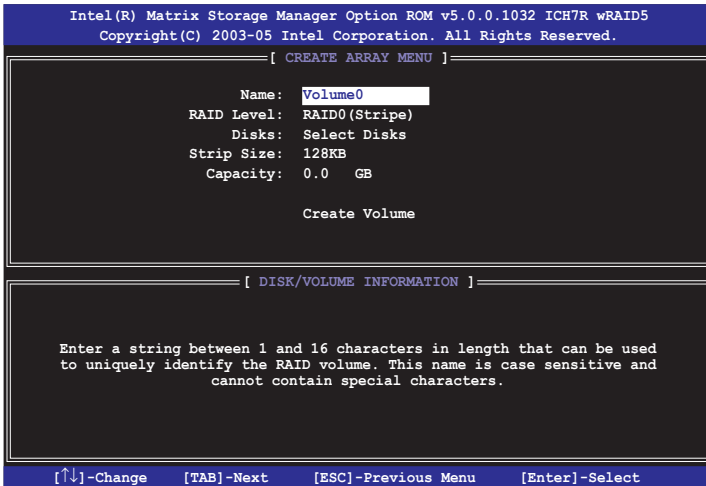

2. Enter a name for the RAID 0 set, then press <Enter>.
3. When the **RAID Level** item is highlighted, press the up/down arrow key to select **RAID 0(Stripe)**, then press <Enter>.
4. When the **Disks** item is highlighted, press <Enter> to select the hard disk drives to configure as RAID. This **SELECT DISKS** screen appears.

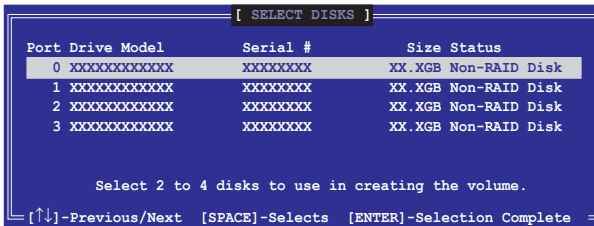

5. Use the up/down arrow key to highlight a drive, then press <Space> to select. A small triangle marks the selected drive. Press <Enter> after completing your selection.

6. Use the up/down arrow key to select the stripe size for the RAID 0 array, then press <Enter>. The available stripe size values range from 8 KB to 128 KB. The default stripe size is 128 KB.



TIP: We recommend a lower stripe size for server systems, and a higher stripe size for multimedia computer systems used mainly for audio and video editing.

7. Key in the RAID volume capacity that you want, then press <Enter>. The default value indicates the maximum allowed capacity.
8. Press <Enter> when the **Create Volume** item is highlighted. This warning message appears.

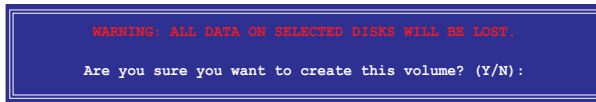

9. Press <Y> to create the RAID volume and return to the main menu, or <N> to go back to the Create Volume menu.

5.2.2 Creating a RAID 1 set (mirrored)

To create a RAID 1 set:

1. From the utility main menu, select **1. Create RAID Volume**, then press <Enter>. This screen appears.

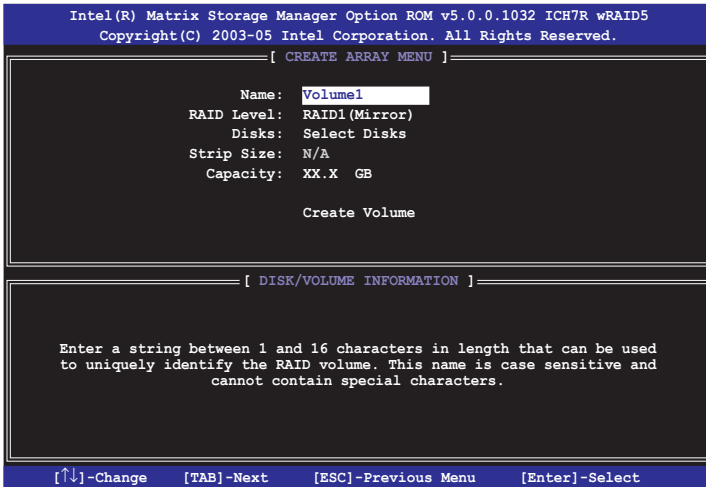

2. Enter a name for the RAID 1 set, then press <Enter>.
3. When the **RAID Level** item is highlighted, press the up/down arrow key to select **RAID 1 (Mirror)**, then press <Enter>.
4. When the **Disks** item is highlighted, press <Enter> to select the hard disk drives to configure as RAID. The **SELECT DISKS** screen appears.
5. Use the up/down arrow key to highlight a drive, then press <Space> to select. A small triangle marks the selected drive. Press <Enter> after completing your selection.
6. When the **Capacity** item is highlighted, key in the RAID volume capacity that you want, then press <Enter>. The default value indicates the maximum allowed capacity.
7. Press <Enter> when the **Create Volume** item is highlighted. This warning message appears.

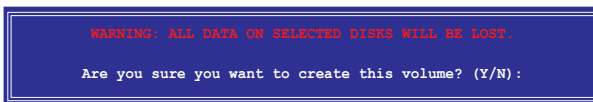

8. Press <Y> to create the RAID volume and return to main menu or <N> to go back to Create Volume menu.

5.2.3 Creating a RAID 10 set (RAID 0+1)

To create a RAID 10 set:

1. From the utility main menu, select **1. Create RAID Volume**, then press <Enter>. This screen appears.

```
Intel(R) Matrix Storage Manager Option ROM v5.0.0.1032 ICH7R wRAID5
Copyright(C) 2003-05 Intel Corporation. All Rights Reserved.

[ CREATE ARRAY MENU ]

Name: Volume10
RAID Level: RAID10 (RAID0+1)
Disks: Select Disks
Strip Size: 128KB
Capacity: XXX.X GB

Create Volume

[ DISK/VOLUME INFORMATION ]

Enter a string between 1 and 16 characters in length that can be used
to uniquely identify the RAID volume. This name is case sensitive and
cannot contain special characters.

[↑↓]-Change [TAB]-Next [ESC]-Previous Menu [Enter]-Select
```

2. Enter a name for the RAID 10 set, then press <Enter>.
3. When the **RAID Level** item is highlighted, press the up/down arrow key to select **RAID 10(RAID0+1)**, then press <Enter>.
4. When the **Disks** item is highlighted, press <Enter> to select the hard disk drives to configure as RAID. The **SELECT DISKS** screen appears.
5. Use the up/down arrow key to highlight a drive, then press <Space> to select. A small triangle marks the selected drive. Press <Enter> after completing your selection.
6. When the **Stripe Size** item is highlighted, press the up/down arrow key to select the stripe size for the RAID 10 array, then press <Enter>. The available stripe size values range from 8 KB to 128 KB. The default stripe size is 64 KB.



TIP: We recommend a lower stripe size for server systems, and a higher stripe size for multimedia computer systems used mainly for audio and video editing.

7. Key in the RAID volume capacity that you want then press <Enter> when the **Capacity** item is highlighted. The default value indicates the maximum allowed capacity.

- Press <Enter> when the **Create Volume** item is highlighted. This warning message appears.

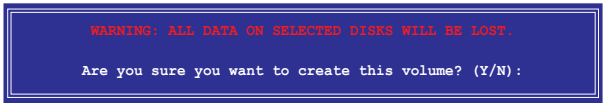

- Press <Y> to create the RAID volume and return to the main menu or <N> to go back to the Create Volume menu.

5.2.4 Creating a RAID 5 set (parity)

To create a RAID 5 set:

- From the utility main menu, select **1. Create RAID Volume**, then press <Enter>. This screen appears.

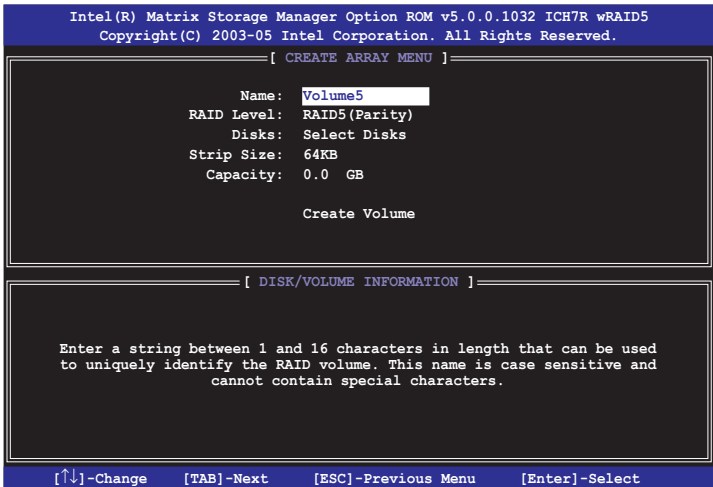

- Enter a name for the RAID 5 set, then press <Enter>.
- When the **RAID Level** item is highlighted, press the up/down arrow key to select **RAID 5(Parity)**, then press <Enter>.

- When the **Disks** item is highlighted, press <Enter> to select the hard disk drives to configure as RAID. The **SELECT DISKS** screen appears.

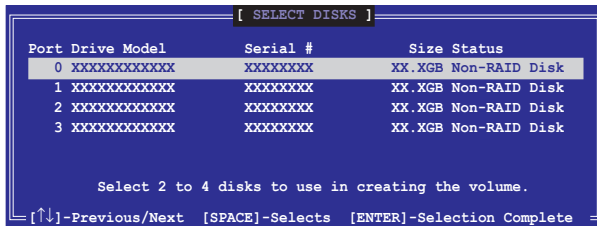

- Use the up/down arrow key to highlight the drive you want to set, then press <Space> to select. A small triangle marks the selected drive. Press <Enter> after completing your selection.
- When the **Stripe Size** item is highlighted, press the up/down arrow key to select the stripe size for the RAID 5 array, then press <Enter>. The available stripe size values range from 8 KB to 128 KB. The default stripe size is 64 KB.



TIP: We recommend a lower stripe size for server systems, and a higher stripe size for multimedia computer systems used mainly for audio and video editing.

- Key in the RAID volume capacity that you want, then press <Enter> when the **Capacity** item is highlighted. The default value indicates the maximum allowed capacity.
- Press <Enter> when the **Create Volume** item is highlighted. This warning message appears.



- Press <Y> to create the RAID volume and return to the main menu or <N> to go back to the Create Volume menu.

5.2.5 Deleting a RAID set



Take caution when deleting a RAID set. You will lose all data on the hard disk drives when you delete a RAID set.

To delete a RAID set:

1. From the utility main menu, select **2. Delete RAID Volume**, then press <Enter> to display this screen.

```
Intel(R) Matrix Storage Manager Option ROM v5.0.0.1032 ICH7R wRAID5
Copyright(C) 2003-05 Intel Corporation. All Rights Reserved.

[ DELETE VOLUME MENU ]

Name          Level          Drives          Capacity        Status          Bootable
Volume0       RAIDX (xxxxx)   X                XXX.XGB        Normal          Yes

[ HELP ]

Deleting a volume will destroy the volume data on the drive(s) and
cause any member disks to become available as non-RAID disks.

WARNING: EXISTING DATA WITHIN THIS VOLUME WILL BE LOST AND NON-RECOVERABLE.

[↑↓]-Select      [ESC]-Previous Menu      [Del]-Delete Volume
```

2. Use the up/down arrow key to select the RAID set you want to delete, then press . This window appears.

```
[ DELETE VOLUME VERIFICATION ]

ALL DATA IN THE VOLUME WILL BE LOST!

Are you sure you want to delete volume "VolumeX"? (Y/N):
```

3. Press <Y> to delete the RAID set and return to the utility main menu; otherwise, press <N> to return to the Delete Volume menu.

5.2.6 Resetting Disks to Non-RAID



Take caution before you reset a RAID volume HDD to non-RAID. Resetting a RAID volume HDD deletes all internal RAID structure on the drive.

To reset a RAID set hard disk drive:

1. From the utility main menu, select **3. Reset Disks to Non-RAID**, then press <Enter> to display this screen.

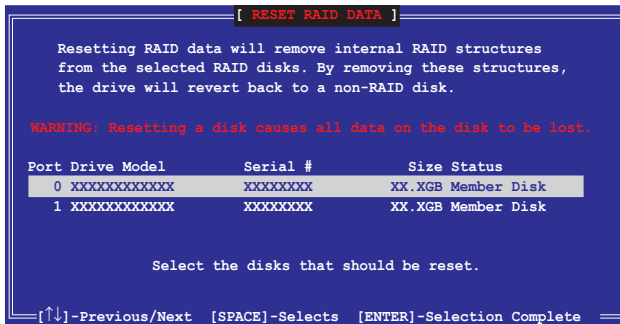

2. Use the up/down arrow key to highlight the RAID set drive you want to reset, then press <Space> to select.
3. Press <Enter> to reset the RAID set drive. A confirmation message appears.
4. Press <Y> to reset the drive or press <N> to return to the utility main menu.
5. Follow steps 2 to 4 to select and reset other RAID set drives.

5.2.7 Exiting the Intel® Matrix Storage Manager utility

To exit the utility:

1. From the utility main menu, select **4. Exit**, then press <Enter>. This window appears.

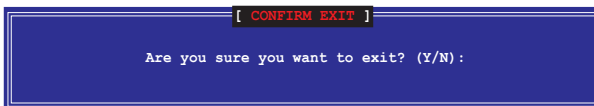

2. Press <Y> to exit or press <N> to return to the utility main menu.

5.2.8 Rebuilding the RAID



This option is only for the RAID 1, RAID 5 and RAID 10 sets.

Rebuilding the RAID with other non-RAID disk

If any of the SATA hard disk drives included in the RAID array failed, the system displays the status of the RAID volume as **“Degraded”** during POST. You can rebuild the RAID array with other installed non-RAID disks.

To rebuild the RAID with other non-RAID disk:

1. At the prompt, press <Ctrl> + <I> to enter the Intel Matrix Storage Manager RAID configuration.
2. If there is a non-RAID SATA Hard Disk available, the utility will prompt to rebuild the RAID. Press <Enter>, then use up/down arrow keys to select the destination disk or press <ESC> to exit.

```
[ DEGRADED VOLUME DETECTED ]
"Degraded" volume and disk available for rebuilding detected.
Selecting a disk initiates a rebuild. Rebuild completes in the
operating system.

Select the port of destination disk for rebuilding (ESC to exit):

Port Drive Model      Serial#      Size
3HDS722580VLSA80     VN6Bxxxx    76.7GB

[↑↓]- Previous/Next   [Enter]- Selects   [ESC]- Exit
```



Select a destination disk with the same size as the original hard disk.

3. The utility immediately starts rebuilding after the disk is selected. The status of the degraded RAID volume is changed to **“Rebuild”**.

```
Copyright(C) 2003-05 Intel Corporation. All Rights Reserved.
*****[ MAIN MENU ]*****
1. Create RAID Volume
2. Delete RAID Volume
3. Reset Disks to Non-RAID
4. Exit
*****

*****[ DISK/VOLUME INFORMATION ]*****
RAID Volumes:
* ID Name Level Strip Size Status Bootable *
* 0 Volume0 RAID1(Mirror) N/A 74.5GB Rebuild Yes *
*
* Physical Disks:
* Port Drive Model Serial # Size Type/Status(Vol ID) *
* 1 ST380013AS 5JV7KSE9 74.5GB Member Disk(0) *
* 3 HDS722580VLSA80 VN6BHECBW1EKMC 76.7GB Member Disk(0) *
*
*
* Volumes with "Rebuild" status will be rebuilt within the operating system. *
*****
[**]-Select [ESC]-Exit [ENTER]-Select Menu
```

4. Exit the RAID configuration utility and reboot the system.
5. Select **Start > Programs > Intel Matrix Storage > Intel Matrix Storage Console** or click the **Intel Matrix Storage Manager** tray icon to load the Intel Matrix Storage Manager utility.
6. From the **View** menu, select **Advanced Mode** to display the details of the Intel Matrix Storage Console.
7. From the **Volumes view** option, select **RAID volume** to view the rebuilding status. When finished, the status is changed to **“Normal”**.

Rebuilding the RAID with a new hard disk

If any of the SATA hard disk drives included in the RAID array failed, the system displays the status of the RAID volume as **“Degraded”** during POST. You may replace the disk drive and rebuild the RAID array.

To rebuild the RAID with a new hard disk:

1. Remove the failed SATA hard disk and install a new SATA hard disk of the same specification into the same SATA Port.



Select a destination disk with the same size as the original hard disk.

2. Reboot the system and then follow the steps in section **“Rebuilding the RAID with other non-RAID disk”** on page 5-12.

5.2.9 Setting the Boot array in the BIOS Setup Utility

You can set the boot priority sequence in the BIOS for your RAID arrays when creating multi-RAID using the Intel® Matrix Storage Manager.



Set at least one of the arrays bootable to boot from the hard disk.

To set the boot array in the BIOS:

1. Reboot the system and press to enter the BIOS setup utility during POST.
2. Go to the **Boot** menu and select the option **Boot Device Priority**.
3. Use up/down arrow keys to select the boot priority and press <Enter>. Refer to “4.6.1 Boot Device Priority” for details.
4. From the **Exit** menu, select **Exit & Save Changes**, then press <Enter>.
5. When the confirmation window appears, select **OK**, then press <Enter>.

5.3 LSI Logic Embedded SATA RAID Setup Utility

The LSI Logic Embedded SATA RAID Setup Utility allows you to create RAID 0, RAID 1, and RAID 10 set(s) from SATA hard disk drives connected to the SATA connectors supported by the motherboard Southbridge chip.



The LSI Logic Embedded SATA RAID automatically configures a RAID 1 (Mirrored) set when the SATA is configured as **RAID** in the BIOS and you installed two hard disk drives without a RAID configuration.

To enter the LSI Logic Embedded SATA RAID Setup Utility:

1. Turn on the system after installing all the SATA hard disk drives.
2. During POST, the LSI Logic Embedded SATA RAID Setup Utility automatically detects the installed SATA hard disk drives and displays any existing RAID set(s). Press <Ctrl> + <M> to enter the utility.

```
LSI Logic Embedded SATA RAID BIOS Version 5.4.06091652R
(c)2004 Copyright LSI Logic Corporation. All Rights Reserved.

LSI Logic Embedded SATA RAID Found at PCI Bus No:00 Dev No:1F
Scanning for Port 0 ... Responding. ST380013AS      76319MB      UDMA 6
Scanning for Port 1 ... Responding. ST380013AS      76319MB      UDMA 6
Scanning for Port 2 ... Responding. ST380023AS      76319MB      UDMA 6
Scanning for Port 3 ... Responding. ST380023AS      76319MB      UDMA 6

LSI Logic Embedded SATA RAID Not Configured!

New Drive(s) Found.

Press Ctrl-M to run LSI Logic Embedded SATA RAID Setup Utility.
```



You may also create a RAID set(s) in a Windows® operating environment using the Global Array Manager (GAM) application. Refer to the GAM user guide in the motherboard support CD for details.

- The utility main window appears. Use the arrow keys to select an option from the **Management Menu**, then press <Enter>. Refer to the Management Menu descriptions below.

At the bottom of the screen is the legend box. The keys on the legend box allow you to navigate through the setup menu options or execute commands. The keys on the legend box vary according to the menu level.



Menu	Description
Configure	Allows you to create RAID 0, RAID 1, or RAID 10 set using the Easy Configuration or the New Configuration command. This menu also allows you to view, add, or clear RAID configurations or select the boot drive
Initialize	Allows you to initialize the logical drives of a created RAID set
Objects	Allows you to initialize logical drives or change the logical drive parameters
Rebuild	Allows you to rebuild failed drives
Check Consistency	Allows you to check the data consistency of the logical drives of a created RAID set

5.3.1 Creating a RAID set

The LSI Logic Embedded SATA RAID Setup Utility allows you to create a RAID 0 or RAID 1 set using two types of configurations: **Easy** and **New**.

In **Easy Configuration**, the logical drive parameters are set automatically including the size and stripe size (RAID 1 only).

In **New Configuration**, you manually set the logical drive parameters and assign the set size and stripe size (RAID 1 only).

Using Easy Configuration

To create a RAID set using the **Easy Configuration** option:

1. From the utility main menu, highlight **Configure**, then press <Enter>.
2. Use the arrow keys to select **Easy Configuration**, then press <Enter>.

```
***** Configuration Menu *****
***** Easy Configuration *****
***** Management *****
***** Configure *****
***** Initialize *****
***** Objects *****
***** Rebuild *****
***** Check Consistency *****
***** New Configuration *****
***** View/Add Configuration *****
***** Clear Configuration *****
***** Select Boot Drive *****
*****
***** Defines Physical Arrays. An Array Will Automatically Become A Logical Drive *****
***** Use Cursor Keys To Navigate Between Items And Press Enter To Select An Option *****
```

3. The **ARRAY SELECTION MENU** displays the available drives connected to the SATA ports. Select the drives you want to include in the RAID set, then press <SpaceBar>. When selected, the drive indicator changes from **READY** to **ONLIN A[X]-[Y]**, where X is the array number, and Y is the drive number.

```
***** Easy Configuration - ARRAY SELECTION MENU *****
***** Management *****
***** Configure *****
***** Initialize *****
***** Objects *****
***** Rebuild *****
***** Check Consis *****
*****
***** PORT # *****
***** 0 *****
***** 1 *****
*****
***** Port # 0 DISK 114376MB HDS722512VLSA80 V930A6MA *****
***** SPACE-Sel, ENTER-EndArray, F10-Configure, F2-Drv. Info, F9-Logical Drives *****
```



The information of the selected hard disk drive displays at the bottom of the screen.

6. Select **RAID** from the **Logical Drive** menu, then press <Enter>.
7. Select the RAID level from the menu, then press <Enter>.



You need at least two identical hard disk drives when creating a RAID 1 set.

```

***** Logical Drive(s) Configured *****
***** LD  RAID  Size  #Stripes  StripeSz  Status *****
***** 0    1    114376MB  2        64 KB    ONLINE *****
***** Manage *****
***** Configure *****
***** Initialize *****
***** Objects *****
***** Rebuild *****
***** Check Con *****
*****
***** Logical Drive 0 ***** RAID Level *****
***** RAID = 1 ***** RAID 0 *****
***** Size = 114376MB ***** RAID 1 *****
***** Stripe Size *****
***** Accept *****
***** SPAN = NO *****
*****
***** Choose RAID Level For This Logical Drive *****
Use Cursor Keys To Navigate Between Items And Press Enter To Select An Option

```

8. When creating a **RAID 1** or a **RAID 10** set, select **Stripe Size** from the **Logical Drive** menu, then press <Enter>.

When creating a **RAID 0** set, proceed to step 10.
9. Key in the stripe size, then press <Enter>.

```

***** Logical Drive(s) Configured *****
***** LD  RAID  Size  #Stripes  StripeSz  Status *****
***** 0    1    114376MB  2        64 KB    ONLINE *****
***** Manage *****
***** Configure *****
***** Initialize *****
***** Objects *****
***** Rebuild *****
***** Check C *****
***** Enter Stripe Size In KB (4,8,16,32,64,128)? :64 *****
*****
***** Logical Drive 0 *****
***** RAID = 1 *****
***** Size = 114376MB *****
***** Stripe Size *****
***** Accept *****
***** SPAN = NO *****
*****
***** Enter Stripe Size In KB (4,8,16,32,64,128)? : *****
Use Cursor Keys To Navigate Between Items And Press Enter To Select An Option

```



For server systems, we recommend that you use a lower array block size. For multimedia computer systems used mainly for audio and video editing, we recommend a higher array block size for optimum performance.

5.3.2 Adding or viewing a RAID configuration

You can add a new RAID configuration or view an existing configuration using the **View/Add Configuration** command.

Adding a new RAID configuration

To add a new RAID configuration:

1. From the Management Menu, highlight **Configure**, then press <Enter>.
2. Use the arrow keys to select **View/Add Configuration**, then press <Enter>.

```
==== Configuration Menu =====
*** Management ***
*** Configure ***
*** Initialize ***
*** Objects ***
*** Rebuild ***
*** Check Consistency ***
*** View/Add Configuration ***
*** Clear Configuration ***
*** Select Boot Drive ***

==== View/Add To The Existing Configuration =====
Use Cursor Keys To Navigate Between Items And Press Enter To Select An Option
```

3. The **ARRAY SELECTION MENU** displays the available drives connected to the SATA ports. Select the drive(s) you want to include in the RAID set, then press <SpaceBar>. When selected, the drive indicator changes from **READY** to **ONLIN A[X]-[Y]**, where X is the array number, and Y is the drive number.

```
==== View/Add Configuration - ARRAY SELECTION MENU=====
*** Management ***
*** Configure ***
*** Initialize ***
*** Objects ***
*** Rebuild ***
*** Check Consistency ***

PORT #
0-READY
1-ONLIN A00-B0

Port # 0 DISK 114376MB HDST22512VL5A90 V3006MA
SPACE-Sel ENTER-EndArray F10-Configure F2-Drv Info F3-Logical Drives
```



The information of the selected hard disk drive displays at the bottom of the screen.

6. Follow steps 6 to 7 of the **Creating a RAID set: Using Easy Configuration** section.
7. Select **Size** from the **Logical Drive** menu, then press <Enter>.
8. Key in the desired logical drive size, then press <Enter>.

```

***** Logical Drive(s) Configured *****
***** LD   RAID   Size   #Stripes   StripeSz   Status *****
***** 0     1     114376MB   2          64 KB     ONLINE *****
***** Management *****
***** Configuration *****
***** Initialize *****
***** Objects *****
***** Rebuild *****
***** Check C *****
***** Enter Logical Drive Size (MB) :114376 *****
***** Logical Drive 0 *****
***** RAID = 1 *****
***** Size = 114376MB *****
***** Stripe Size *****
***** Accept *****
***** SPAN = NO *****
***** Enter Logical Drive Size (MB) : *****
***** Use Cursor Keys To Navigate Between Items And Press Enter To Select An Option *****

```

9. Follow steps 8 to 12 of the **Creating a RAID set: Using Easy Configuration** section to add the new RAID configuration.

5.3.3 Initializing the logical drives

After creating the RAID set(s), you must initialize the logical drives. You may initialize the logical drives of a RAID set(s) using the **Initialize** or **Objects** command in the Management Menu.

Using the Initialize command

To initialize the logical drive using the **Initialize** command:

1. From the Management Menu, highlight **Initialize**, then press <Enter>.

```
*****
*****
***** Management Menu *****
***** Configure *****
***** Initialize *****
***** Objects *****
***** Rebuild *****
***** Check Consistency *****
*****
*****
***** Initialize Logical Drive(s) *****
***** Use Cursor Keys To Navigate Between Items And Press Enter To Select An Option *****
```

2. The screen displays the available RAID set(s) and prompts you to select the logical drive to initialize. Use the arrow keys to select the logical drive from the **Logical Drive** selection, then press <Enter>.

```
*****
***** Logical Drive(s) Configured *****
***** Management Menu ***** LD RAID Size #Stripes StripeSz Status *****
***** Configure *****
***** Initialize ***** 0 1 114376MB 2 64 KB ONLINE *****
***** Objects *****
***** Rebuild *****
***** Check Consistency *****
*****
*****
***** Logical Drives *****
***** Logical Drive *****
*****
*****
***** Select Logical Drive *****
***** SPACE-(De)Select, F10-Initialize *****
```

- 5. When prompted, press the <SpaceBar> to select **Yes** from the **Initialize?** dialog box, then press <Enter>. You may also press <F10> to initialize the drive without confirmation.

```
*****Logical Drives(1)*****
*****Logical Drive 0*****
*****Obj*****
Management*Adapter
Configure *Logical Drive
Initialize *Physical Drive
*****Objects*****
Rebuild *****Logical Drive 0*****
Check Consistency *****Initialize*****
*****Check Consistency*****
*****View/Update*****
*****Yes*****
*****No*****
*****
***** Initialize Will Destroy Data On Selected Logical Drive(s). *****
Use Cursor Keys To Navigate Between Items And Press Enter To Select An Option
```

- 6. A progress bar appears on screen. If desired, press <Esc> to abort initialization.

```
*****Logical Drives(1)*****
*****Logical Drive 0*****
*****Obj*****
Management*Adapter
Configure *Logical Drive
Initial***** Initialize Logical Drives In Progress*****
*****Objects*****
Rebuild *****Array Initialization Under Progress. Press ESC to ABORT*****
*****Check C*****
*****
***** / 23 % Completed *****
*****
*****
*****
Use Cursor Keys To Navigate Between Items And Press Enter To Select An Option
```

- 7. When initialization is completed, press <Esc>.

```
*****Logical Drives(1)*****
*****Logical Drive 0*****
*****Obj*****
Management*Adapter
Configure *Logical Drive
Initial***** Initialize Logical Drives In Progress*****
*****Objects*****
Rebuild *****Array Initialization Complete !! Press ESC..*****
*****Check C*****
*****
***** | 100% Completed *****
*****
*****
*****
Use Cursor Keys To Navigate Between Items And Press Enter To Select An Option
```

- After selecting the drive to rebuild, press <F10>. The indicator for the selected drive now shows **RBLD**.

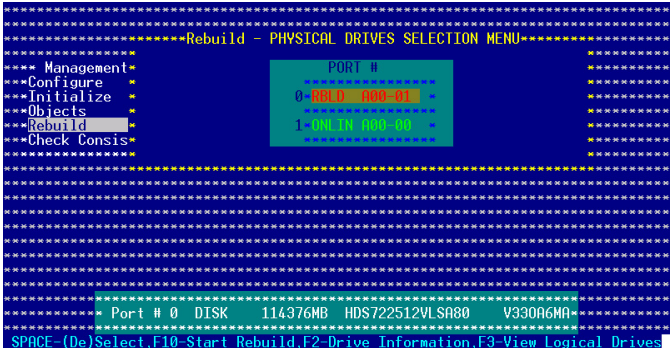

- When prompted, press <Y> to to rebuild the drive.

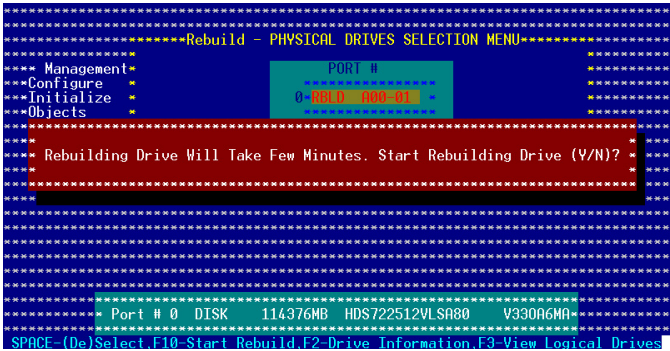

- When rebuild is complete, press any key to continue.

Using the Objects command

To rebuild a failed hard disk drive using the **Objects** command:

- From the Management Menu, select **Objects**, then select **Physical Drive** from the menu.
- Use the arrow keys to select the physical drive you want to rebuild, then press <Enter>.
- Select **Rebuild** from the pop-up menu, then press <Enter>.
- When prompted, press <Y> to to rebuild the drive.
- When rebuild is complete, press any key to continue.

5.3.5 Checking the drives for data consistency

You can check and verify the accuracy of data redundancy in the selected logical drive. The utility can automatically detect and/or detect and correct any differences in data redundancy depending on the selected option in the **Objects > Adapter** menu.



The Check Consistency command is available only for logical drives included in a RAID 1 set.

Using the Check Consistency

To check data consistency using the **Check Consistency** command:

1. From the Management Menu, select **Check Consistency**, then press <Enter>.

```
*****
*****
***** Management Menu *****
*****
***** Configure *****
***** Initialize *****
***** Objects *****
***** Rebuild *****
***** Check Consistency *****
*****
*****
*****
*****
*****
*****
*****
***** Check Consistency Of Logical Drive(s) *****
*****
***** Use Cursor Keys To Navigate Between Items And Press Enter To Select An Option *****
```

2. The screen displays the available RAID set(s) and prompts you to select the logical drive to check. Use the arrow keys to select the logical drive from the **Logical Drive** selection, then press <Enter>.

```
*****
*****
***** Management Menu ***** LD RAID Logical Drive(s) Configured *****
***** Configure ***** Size #Stripes StripeSz Status *****
***** Initialize ***** 0 1 114376MB 2 64 KB ONLINE *****
***** Objects *****
***** Rebuild *****
***** Check Consistency *****
*****
*****
***** Logical Drives *****
*****
*****
*****
***** Select Logical Drive *****
*****
***** SPACE-(De)Select, F10-Check Consistency *****
```

- When prompted, press the <SpaceBar> to select **Yes** from the **Consistency Check** dialog box, then press <Enter>. You may also press <F10> to check the drive consistency.

```

*****
***** Logical Drive(s) Configured *****
Management Menu ** LD  RAID  Size  #Stripes  StripeSz  Status
*****
** Configure
** Initialize * 0  1  114376MB  2  64  KB  ONLINE
** Objects
** Rebuild
** Check Consistency
*****
***** Consistency Check *****
*****
***** Yes *****
***** No *****
*****
***** Logical Drives *****
*****
***** Select Logical Drive *****
*****
SPACE-(De)Select. F10-Check Consistency

```

A progress bar appears on screen.

```

*****
***** Logical Drive(s) Configured *****
Management Menu ** LD  RAID  Size  #Stripes  StripeSz  Status
*****
** Configure
** Initial ***** Consistency Check ***** ONLINE
** Objects
** Rebuild ***** Consistency Check Under Progress. Press ESC to ABORT. *****
** Check
*****
***** / 0 % Completed *****
*****
***** Logical *****
*****
***** Select Logical Drive *****
*****
SPACE-(De)Select. F10-Check Consistency

```

- While checking the disk consistency, press <Esc> to display the following options.
 - Stop - Stops the consistency check. The utility stores the percentage of disk checked. When you restart checking, it continues from the last percentage completed rather than from zero percent.
 - Continue - Continues the consistency check.
 - Abort - Aborts the consistency check. When you restart checking, it continues from zero percent.
- When checking is complete, press any key to continue.

Using the Objects command

To check data consistency using the **Objects** command:

1. From the Management Menu, select **Objects**, then select **Logical Drive** from the menu.
2. Use the arrow keys to select the logical drive you want to check, then press <Enter>.
3. Select **Check Consistency** from the pop-up menu, then press <Enter>.
4. When prompted, press <Y> to to check the drive.
5. When checking is complete, press any key to continue.

5.3.6 Deleting a RAID configuration

To delete a RAID configuration:

1. From the Management Menu, select **Configure > Clear Configuration**, then press <Enter>.

```
***** Configuration Menu *****
***** Easy Configuration *****
***** Management *****
***** Configure *****
***** Initialize *****
***** Objects *****
***** Rebuild *****
***** Check Consistency *****

***** Clear Existing Configuration *****
Use Cursor Keys To Navigate Between Items And Press Enter To Select An Option
```

2. When prompted, press the <SpaceBar> to select **Yes** from the **Clear Configuration?** dialog box, then press <Enter>.

```
***** Configuration Menu *****
***** Easy Configuration *****
***** Management *****
***** Configure *****
***** Initialize *****
***** Objects *****
***** Rebuild *****
***** Check Consistency *****

***** Clear Existing Configuration *****
Use Cursor Keys To Navigate Between Items And Press Enter To Select An Option
```

The utility clears the current array.

3. Press any key to continue.

5.3.7 Selecting the boot drive from a RAID set

You must have created a new RAID configuration before you can select the boot drive from a RAID set. Refer to the **Creating a RAID set: Using New Configuration** section for details.

To select the boot drive from a RAID set:

1. From the Management Menu, select **Configure > Select Boot Drive**, then press <Enter>.

```
***** Configuration Menu *****
** Easy Configuration **
** Management **
** Configure View/Add Configuration **
** Initialize Clear Configuration **
** Objects Select Boot Drive **
** Rebuild **
** Check Consistency **

*****

***** Specify A Logical Drive As Boot Drive On This Adapter *****
Use Cursor Keys To Navigate Between Items And Press Enter To Select An Option
```

2. When prompted, press the <SpaceBar> to select the bootable logical drive from the list, then press <Enter>.

```
***** Bootable Logical Drives (4): Currently (0) *****
** Config Boot Drive 0 **
** Easy Co Boot Drive 1 **
** Management New Con Boot Drive 2 **
** Configure View/Ad Boot Drive 3 **
** Initialize Clear C **
** Objects Select Boot Drive **
** Rebuild **
** Check Consistency **

*****

***** Specify A Logical Drive As Boot Drive On This Adapter *****
Use Cursor Keys To Navigate Between Items And Press Enter To Select An Option
```

3. The logical drive is selected as boot drive. Press any key to continue.

5.3.8 Enabling the WriteCache

You may enable the RAID controller's **WriteCache** option to improve the data transmission performance.



When you enable WriteCache, you may lose data when a power interruption occurs while transmitting or exchanging data among the drives.

To enable WriteCache:

1. From the Management Menu, select **Objects > Adapter**, then press <Enter> to display the adapter properties.
2. Select **WriteCache**, then press <Enter> to turn the option **On** (enabled).

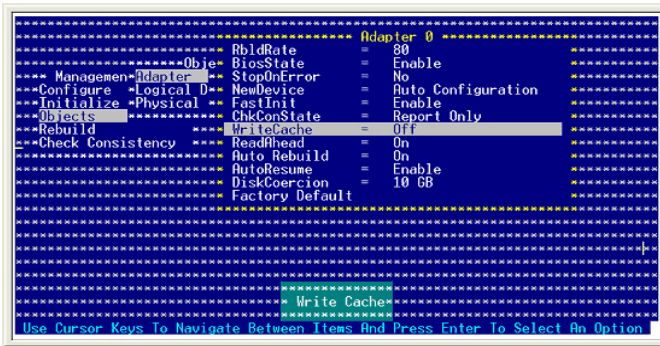

3. When finished, press any key to continue.

5.4 Global Array Manager

You may also create a RAID set(s) in Windows® operating environment using the Global Array Manager (GAM) application. The GAM application is available from the motherboard support CD.



Refer to the GAM user guide in the motherboard support CD for details.

This chapter provides instructions for installing the necessary drivers for different system components.

6 Driver installation

6.1	RAID driver installation.....	6-1
6.2	LAN driver installation	6-11
6.3	VGA driver installation	6-13
6.4	Management applications and utilities installation.....	6-15

6.1 RAID driver installation

After creating the RAID sets for your server system, you are now ready to install an operating system to the independent hard disk drive or bootable array. This part provides instructions on how to install the RAID controller drivers during OS installation.

6.1.1 Creating a RAID driver disk



You may have to use another system to create the RAID driver disk from the system/motherboard support CD or from the Internet.

A floppy disk with the RAID driver is required when installing Windows® 2000 or Red Hat® Enterprise ver. 3.0/SuSE operating system on a hard disk drive that is included in a RAID set. You can create a RAID driver disk in DOS (using the Makedisk application in the support CD).

To create a RAID driver disk in DOS environment:

1. Place the motherboard support CD in the optical drive.
2. Restart the computer, then enter the BIOS Setup.
3. Select the optical drive as the first boot priority to boot from the support CD. Save your changes, then exit the BIOS Setup.
4. Restart the computer.
5. Press any key when prompted to boot from CD.

```
Loading FreeDOS FAT KERNEL GO!  
Press any key to boot from CDROM...
```

The Makedisk menu appears.

```
A) FreeDOS command prompt  
B) Make ICH7R Matrix Storage for Win32 bit driver disk  
C) Make ICH7R Matrix Storage for Win64 bit driver disk  
D) Make Intel ICH7R LSI MegaRAID for Windows 32/64 bit Driver Disk  
E) Make Intel ICH7R LSI MegaRAID for RHEL3 UP6 32/64 bit Driver Disk  
F) Make Intel ICH7R LSI MegaRAID for RHEL4 UP2 32/64 bit Driver Disk  
G) Flash AMI BIOS for P5M2-M  
H) Flash AMI BIOS for P5M2-M/C  
I) Broadcom ASF Firmware Update  
Please choose A To I:
```

6. Place a blank, high-density floppy disk to the floppy disk drive, then select the type of RAID driver disk you want to create by typing the number before the option
7. Press <Enter>.
8. Follow screen instructions to create the driver disk.



For systems with Red Hat® Enterprise versions that are not listed in the Makedisk menu, explore the support CD and copy the RAID driver disk from the following path: `\Drivers\CH7R\LSI\Linux`.

6.1.2 Installing the RAID controller driver

Windows® 2000/2003 Server OS

During Windows® 2000/2003 Server OS installation

To install the RAID controller driver when installing Windows® 2000/2003 Server OS:

1. Boot the computer using the Windows® 2000/2003 Server installation CD. The **Windows® 2000/2003 Setup** starts.

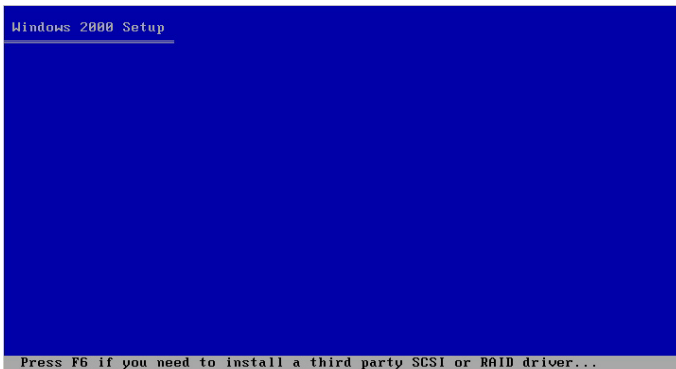

2. Press <F6> when the message “**Press F6 if you need to install a third party SCSI or RAID driver...**” appears at the bottom of the screen.
3. When prompted, press <S> to specify an additional device.

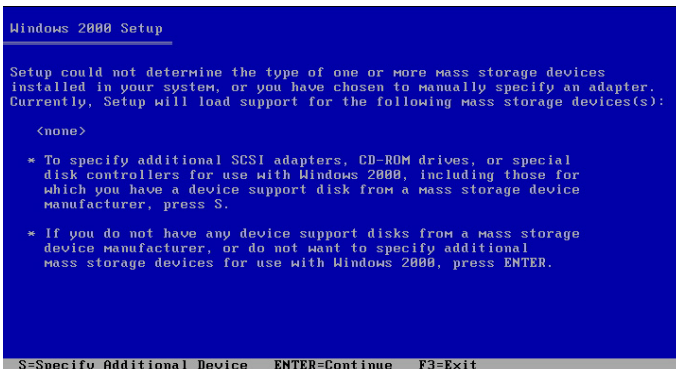

4. Insert the RAID driver disk you created earlier to the floppy disk drive, then press <Enter>.

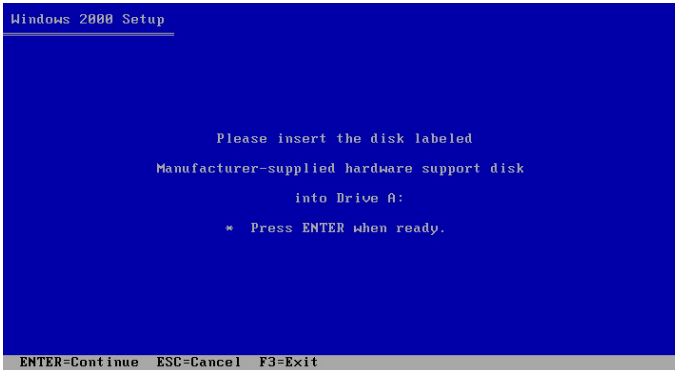

5. Select the RAID controller driver from the list, then press <Enter>.

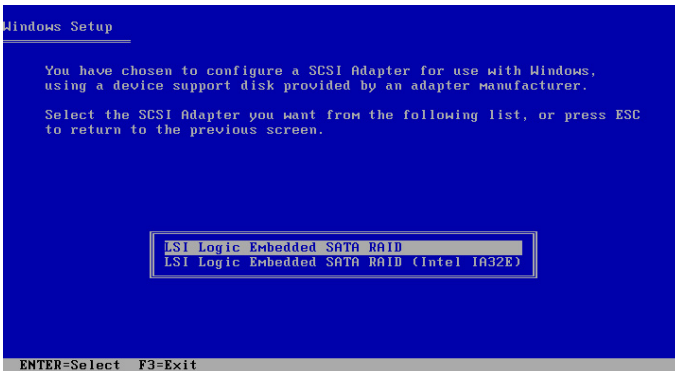

LSI Logic SATA RAID

Select “**LSI Logic Embedded SATA RAID**” for Windows 2000 or 32bit Windows 2003 Server OS from the list, then press <Enter>. For 64bit Windows 2003 Server OS, please select “**LSI Logic Embedded SATA RAID (Intel IA32E)**” item.

```
Windows Setup
*****

You have chosen to configure a SCSI Adapter for use with Windows,
using a device support disk provided by an adapter manufacturer.

Select the SCSI Adapter you want from the following list, or press ESC
to return to the previous screen.

*****
* Intel(R) 82801GR/GH SATA RAID Controller (Desktop ICH7R/DH) *
* Intel(R) 82801GR/GH SATA AHCI Controller (Desktop ICH7R/DH) *
* Intel(R) 82801FR SATA RAID Controller (Desktop ICH6R) *
* Intel(R) 82801FR SATA AHCI Controller (Desktop ICH6R) *
* Intel(R) 82801FBM SATA AHCI Controller (Mobile ICH6M) *
* Intel(R) 82801ER SATA RAID Controller (Desktop ICH5R) *
* Intel(R) 6300ESB SATA RAID Controller *
*****

ENTER=Select F3=Exit
```

Intel Matrix Storage

Select **“Intel(R) 82801GR/GH SATA RAID Controller (Desktop ICH7RDH)”** for Intel Matrix Storage RAID mode from the list, then press <Enter>.

If you configured SATA as AHCI Mode in the BIOS setup utility of IDE Configuration, first install the **Intel SATA AHCI Driver** during windows setup. Then, select the **“Intel(R) 82801GR/GH SATA AHCI Controller (Desktop ICH7RDH)”** from the list. Refer to section “6.1.1 Creating a RAID driver disk” to create the Intel SATA Driver for windows system.

6. The Windows® 2000/2003 Setup loads the RAID controller drivers from the RAID driver disk. When prompted, press <Enter> to continue installation.
7. Setup then proceeds with the OS installation. Follow screen instructions to continue.

To an existing Windows® 2000/2003 Server OS

To install the RAID controller driver on an existing Windows® 2000/2003 Server OS:

1. Restart the computer, then log in with **Administrator** privileges.
2. Windows® automatically detects the RAID controller and displays a **New Hardware Found** window. Click **Cancel**.
3. Right-click the **My Computer** icon on the Windows® desktop , then select **Properties** from the menu.
4. Click the **Hardware** tab then click the **Device Manager** button to display the list of devices installed in the system.

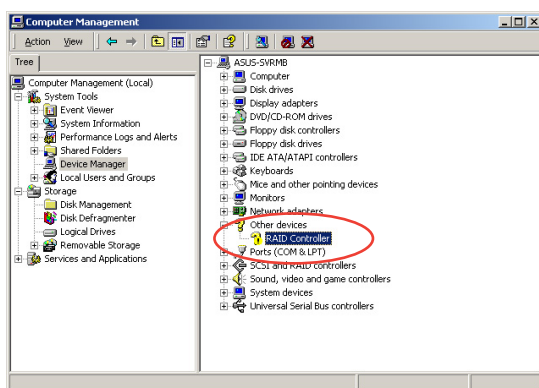

5. Right-click the **RAID controller** item, then select **Properties**.
6. Click the **Driver** tab, then click the **Update Driver** button.
7. The **Upgrade Device Driver Wizard** window appears. Click **Next**.
8. Insert the RAID driver disk you created earlier to the floppy disk drive.
9. Select the option "**Search for a suitable driver for my device (recommended)**", then click Next.
10. The wizard searches the RAID controller drivers. When found, click **Next** to install the drivers.
11. Click **Finish** after the driver installation is done.

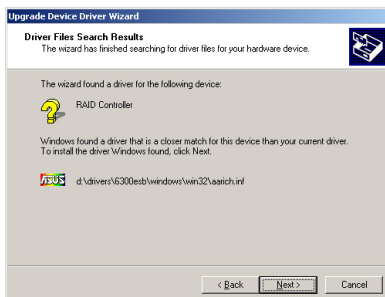

To verify the RAID controller driver installation:

1. Right-click the **My Computer** icon on the Windows® desktop , then select **Properties** from the menu.
2. Click the **Hardware** tab, then click the **Device Manager** button.
3. Click the “+” sign before the item **SCSI and RAID controllers**. The **LSI Logic Embedded SATA RAID** or **Intel® 8201 GR/GH SATA RAID** items should appear.

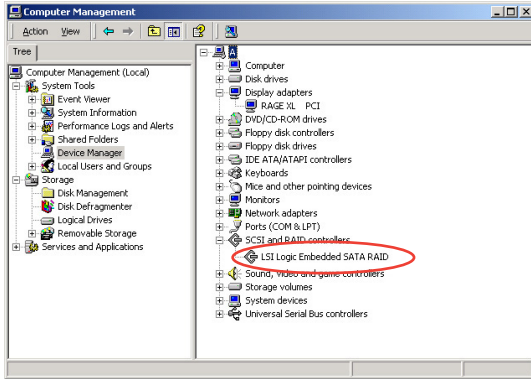

4. Right-click the **RAID controller driver** item, then select **Properties** from the menu.
5. Click the **Driver** tab, then click the **Driver Details** button to display the RAID controller drivers.
6. Click **OK** when finished.

Red Hat® Enterprise ver. 3.0

To install the Intel® ICH7R LSI Logic Embedded SATA RAID controller driver when installing Red Hat® Enterprise ver. 3.0 operating system:

1. Boot the system from the Red Hat® Installation CD.

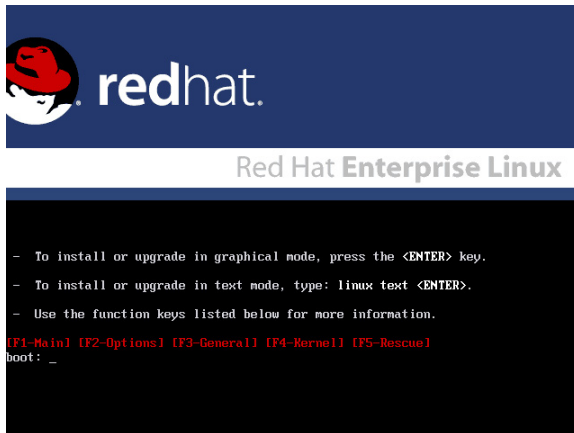

2. At the `boot:`, type `linux dd`, then press <Enter>.

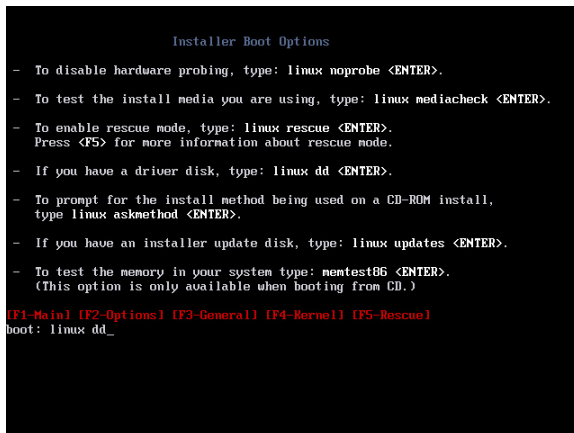

3. Select **Yes** using the <Tab> key when asked if you have the driver disk. Press <Enter>

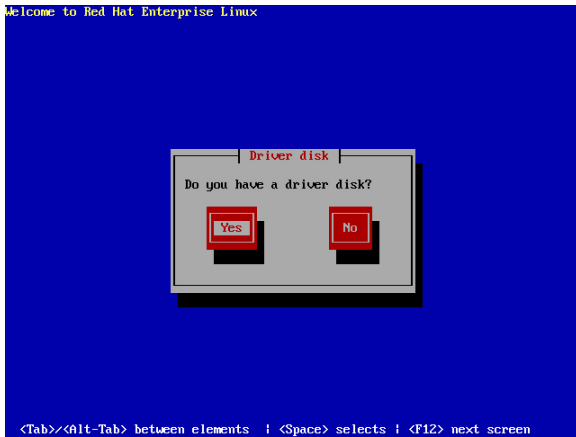

4. Select **fd0** using the <Tab> key when asked to select the driver disk source. Press <Tab> to move the cursor to **OK**, then press <Enter>.

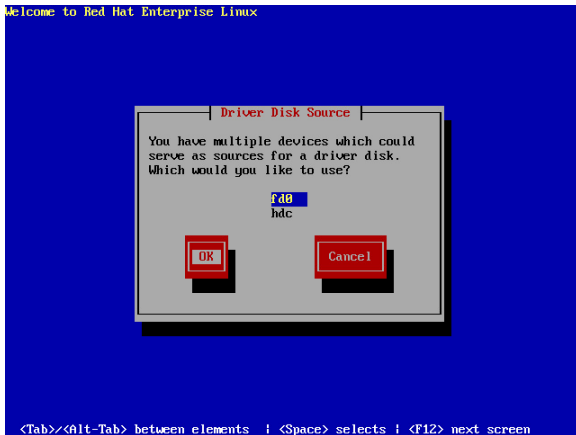

- When prompted, insert the Red Hat® Enterprise ver. 3.0 RAID driver disk to the floppy disk drive, select **OK**, then press <Enter>.

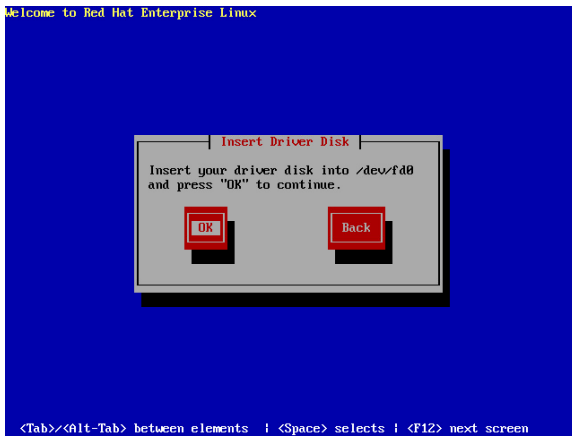

The drivers for the RAID controller are installed to the system.

- When asked if you will load additional RAID controller drivers, select **Yes**, then install the additional RAID controller drivers.

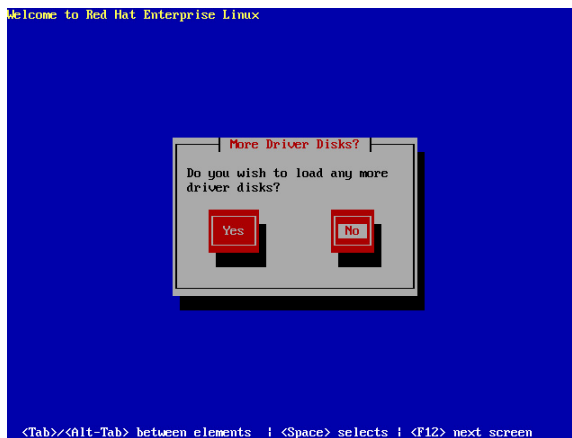

- Follow screen instructions to continue the OS installation.

SuSE Linux

To install the RAID controller driver - when installing SuSE Linux OS:

1. Boot the system from the SuSE Installation CD.
2. Select **Installation** from the **Boot Options** menu, then press <Enter>.

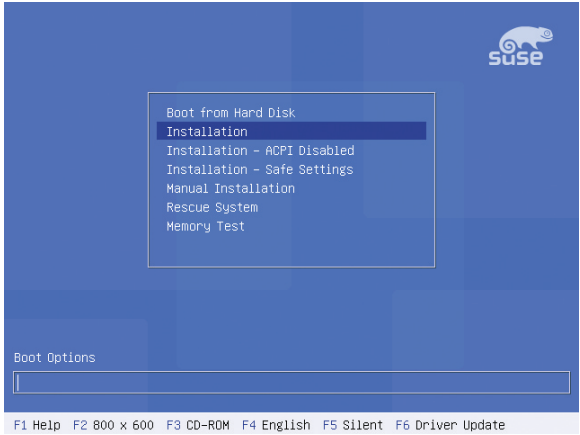

3. A message instructs you to prepare the RAID driver disk. Press <F6>.

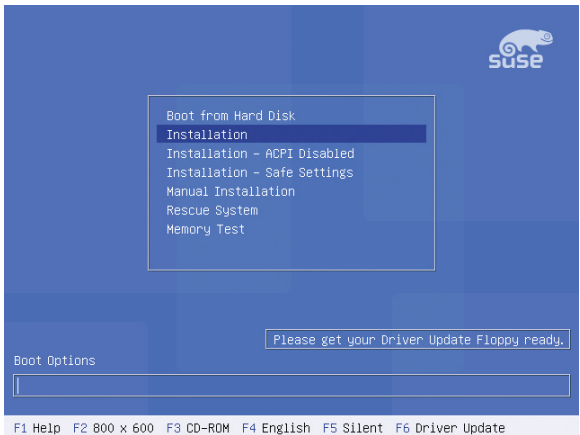

For SuSE Linux Enterprise Server 9.0 SP1 operating system, do not use OS bundled driver, otherwise your computer may become unstable due to OS limitation.

- When prompted, insert the RAID driver disk to the floppy disk drive, then press <Enter>.

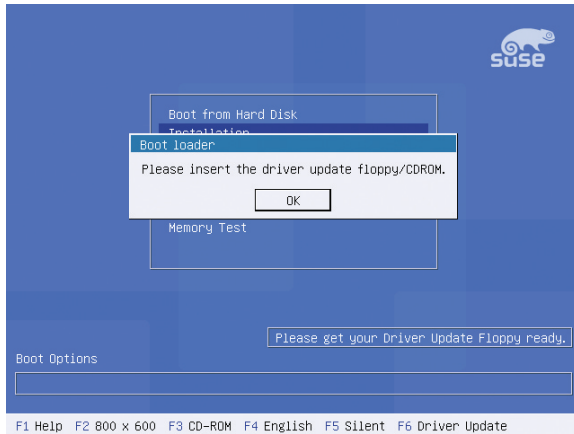

- When prompted, select the floppy disk drive (fd0) as the driver update medium, select **OK**, then press <Enter>.

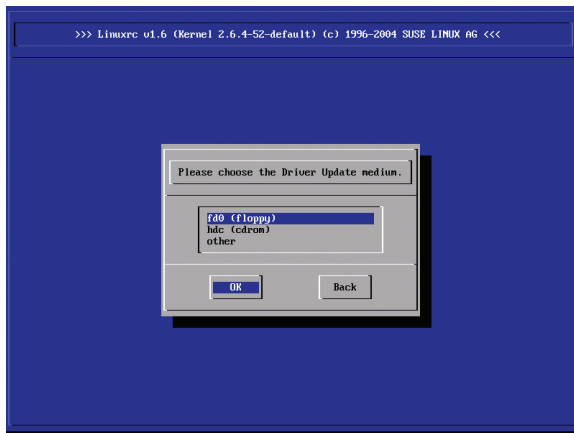

The drivers for the RAID controller are installed to the system.

6.2 LAN driver installation

This section provides instructions on how to install the Broadcom® Gigabit LAN controller drivers.

6.2.1 Windows® 2000/2003 Server

To install the Broadcom® Gigabit LAN controller driver on a Windows® 2000/2003 Server OS:

1. Restart the computer, then log on with **Administrator** privileges.
2. Insert the motherboard/system support CD to the optical drive. The CD automatically displays the **Drivers** menu if Autorun is enabled in your computer.



- Windows® automatically detects the LAN controllers and displays a **New Hardware Found** window. Click **Cancel** to close this window.
- If Autorun is NOT enabled in your computer, browse the contents of the support CD to locate the file ASSETUP.EXE from the BIN folder. Double-click the **ASSETUP.EXE** to run the CD.

3. Click the **Broadcom 5721 Driver** option to begin installation.

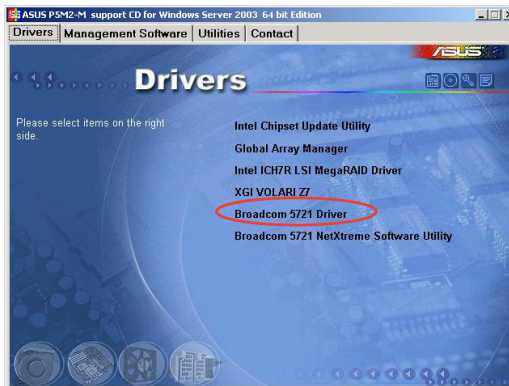

4. Click **Next** when the InstallShield Wizard window appears. Follow screen instructions to continue installation.

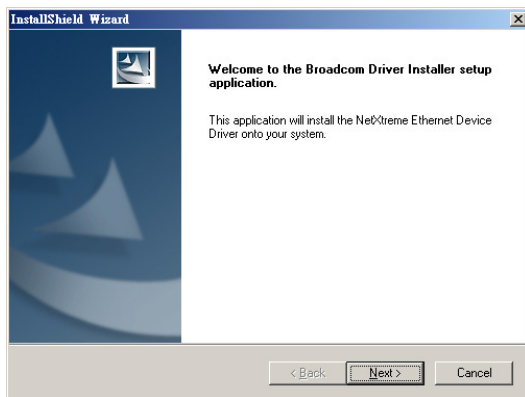

6.2.2 Red Hat® Enterprise ver. 3.0

Follow these instructions when installing the Broadcom® Gigabit LAN controller base driver for the Red Hat® Enterprise ver. 3.0 operating system.

Building the driver from the TAR file



Install first the Kernel Development tools before building the driver from the TAR file.

To build the driver from the TAR file:

1. Create a directory and extract the TAR files:
`tar xvzf bcm5700-<version>.tar.gz`
2. Build the driver `bcm5700.o` as a loadable module for the running kernel:
`cd bcm5700-<version>/src`
`make`
3. Test the driver by loading it:
`insmod bcm5700.o`
4. Install the driver and man page:
`make install`
5. Refer to Red Hat distribution documentation to configure the network protocol and address.

6.3 VGA driver installation

This section provides instructions on how to install the XGI Graphics driver.

6.3.1 Windows® 2000 Server

You need to manually install the XGI Graphics driver on a Windows® 2000 Server operating system.

To install the XGI Graphicsdriver:

1. Restart the computer, then log on with **Administrator** privileges.
2. Insert the motherboard/system support CD to the optical drive. The support CD automatically displays the **Drivers** menu if Autorun is enabled in your computer.



Windows® automatically detects the VGA controller and displays a **New Hardware Found** window. Click **Cancel** to close this window.

3. Click the item **XGI VOLARI Z7** from the Drivers menu.

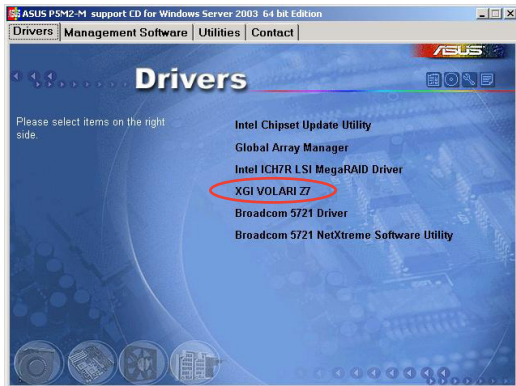

4. The **XGI VOLARI Z7** window appears. Click **Next**. Follow screen instructions to complete installation.

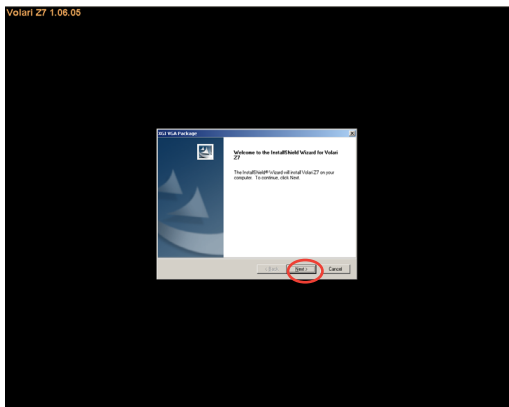

The VGA server does not obtain the authorization from Microsoft® WHQL 2000, but it supports Microsoft® Windows® 2000 Server.

6.3.2 Windows® 2003 Server

The Windows® 2003 Server operating system automatically recognizes the XGI Graphics driver during system installation. There is no need to install an additional driver(s) to support the onboard VGA.

6.3.3 Red Hat® Enterprise ver. 3.0

The Red Hat® Enterprise ver. 3.0 operating system automatically recognizes the XGI Graphics driver during system installation. There is no need to install an additional driver(s) to support the onboard VGA.

6.4 Management applications and utilities installation

The support CD that came with the motherboard package contains the drivers, management applications, and utilities that you can install to avail all motherboard features.



The contents of the support CD are subject to change at any time without notice. Visit the ASUS website (www.asus.com) for updates.

6.4.1 Running the support CD

Place the support CD to the optical drive. The CD automatically displays the Drivers menu if Autorun is enabled in your computer.



If Autorun is NOT enabled in your computer, browse the contents of the support CD to locate the file **ASSETUP.EXE** from the BIN folder. Double-click the **ASSETUP.EXE** to run the CD.

6.4.2 Drivers menu

The Drivers menu shows the available device drivers if the system detects installed devices. Install the necessary drivers to activate the devices.



The screen display and driver options vary under different operating system versions.

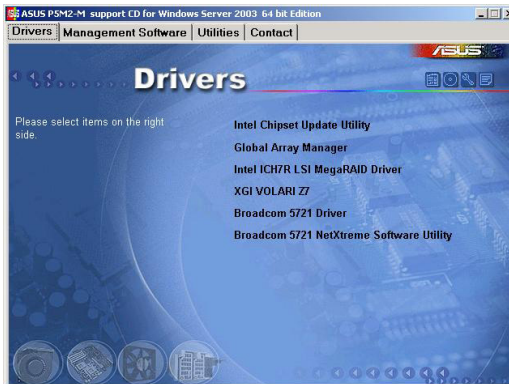

6.4.3 Management Software menu

The **Management Software** menu displays the available network and server monitoring application. Click on an item to install.

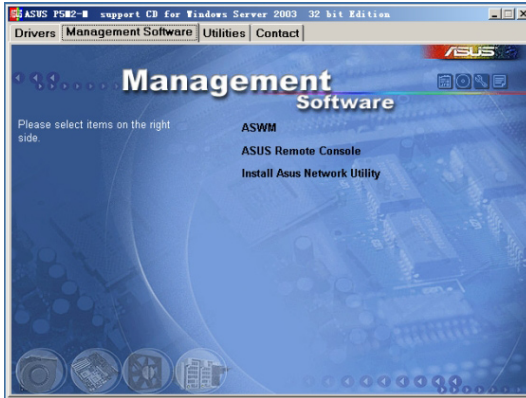

6.4.4 Utilities menu

The **Utilities** menu displays the software applications and utilities that the motherboard supports. Click on an item to install.

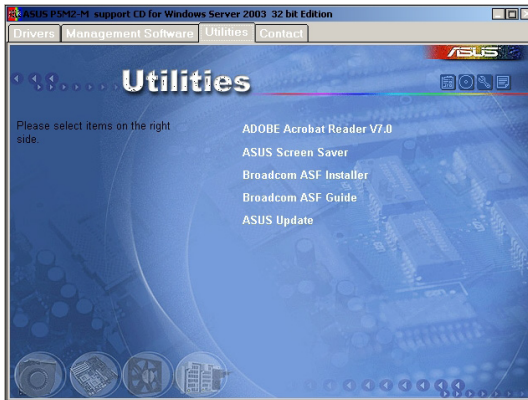

6.4.5 Contact information

Click the **Contact** tab to display the ASUS contact information. You can also find this information on the inside front cover of this user guide.

