

Striker
Extreme

ASUS[®]

Motherboard

E2898

First Edition V1

October 2006

Copyright © 2006 ASUSTeK COMPUTER INC. All Rights Reserved.

No part of this manual, including the products and software described in it, may be reproduced, transmitted, transcribed, stored in a retrieval system, or translated into any language in any form or by any means, except documentation kept by the purchaser for backup purposes, without the express written permission of ASUSTeK COMPUTER INC. ("ASUS").

Product warranty or service will not be extended if: (1) the product is repaired, modified or altered, unless such repair, modification or alteration is authorized in writing by ASUS; or (2) the serial number of the product is defaced or missing.

ASUS PROVIDES THIS MANUAL "AS IS" WITHOUT WARRANTY OF ANY KIND, EITHER EXPRESS OR IMPLIED, INCLUDING BUT NOT LIMITED TO THE IMPLIED WARRANTIES OR CONDITIONS OF MERCHANTABILITY OR FITNESS FOR A PARTICULAR PURPOSE. IN NO EVENT SHALL ASUS, ITS DIRECTORS, OFFICERS, EMPLOYEES OR AGENTS BE LIABLE FOR ANY INDIRECT, SPECIAL, INCIDENTAL, OR CONSEQUENTIAL DAMAGES (INCLUDING DAMAGES FOR LOSS OF PROFITS, LOSS OF BUSINESS, LOSS OF USE OR DATA, INTERRUPTION OF BUSINESS AND THE LIKE), EVEN IF ASUS HAS BEEN ADVISED OF THE POSSIBILITY OF SUCH DAMAGES ARISING FROM ANY DEFECT OR ERROR IN THIS MANUAL OR PRODUCT.

SPECIFICATIONS AND INFORMATION CONTAINED IN THIS MANUAL ARE FURNISHED FOR INFORMATIONAL USE ONLY, AND ARE SUBJECT TO CHANGE AT ANY TIME WITHOUT NOTICE, AND SHOULD NOT BE CONSTRUED AS A COMMITMENT BY ASUS. ASUS ASSUMES NO RESPONSIBILITY OR LIABILITY FOR ANY ERRORS OR INACCURACIES THAT MAY APPEAR IN THIS MANUAL, INCLUDING THE PRODUCTS AND SOFTWARE DESCRIBED IN IT.

Products and corporate names appearing in this manual may or may not be registered trademarks or copyrights of their respective companies, and are used only for identification or explanation and to the owners' benefit, without intent to infringe.

Contents

Notices.....	vii
Safety information	viii
About this guide	ix
Striker Extreme specifications summary	xi
Chapter 1: Product introduction	
1.1 Welcome!	1-1
1.2 Package contents.....	1-1
1.3 Special features.....	1-2
1.3.1 Product highlights	1-2
1.3.2 ASUS AI Lifestyle features	1-4
Chapter 2: Hardware information	
2.1 Before you proceed	2-1
2.2 Motherboard overview	2-2
2.2.1 Placement direction	2-2
2.2.2 Screw holes	2-2
2.2.3 ASUS Stack Cool 2.....	2-3
2.2.4 Motherboard layout.....	2-4
2.2.5 Layout contents.....	2-5
2.3 Central Processing Unit (CPU)	2-7
2.3.1 Installing the CPU	2-8
2.3.2 Installing the CPU heatsink and fan	2-10
2.3.3 Uninstalling the CPU heatsink and fan	2-12
2.3.4 Installing the optional fan	2-14
2.4 System memory	2-15
2.4.1 Overview	2-15
2.4.2 Memory configurations.....	2-16
2.4.3 Installing a DIMM	2-17
2.4.4 Removing a DIMM	2-17
2.5 Expansion slots.....	2-18
2.5.1 Installing an expansion card	2-18
2.5.2 Configuring an expansion card	2-18
2.5.3 Interrupt assignments	2-19
2.5.4 PCI slots.....	2-20

Contents

2.5.5	PCI Express x1 slot.....	2-20
2.5.6	PCI Express x16 slots.....	2-20
2.6	Jumper	2-21
2.7	Audio Card and EL I/O Installation	2-22
2.7.1	Audio Card Installation.....	2-22
2.7.2	EL I/O Installation.....	2-22
2.8	Connectors	2-23
2.8.1	Rear panel connectors.....	2-23
2.8.2	Internal connectors	2-26
2.8.3	Onboard switches	2-37
 Chapter 3: Powering up		
3.1	Starting up for the first time.....	3-1
3.2	Turning off the computer.....	3-2
3.2.1	Using the OS shut down function.....	3-2
3.2.2	Using the dual function power switch.....	3-2
 Chapter 4: BIOS setup		
4.1	Managing and updating your BIOS	4-1
4.1.1	ASUS Update utility	4-1
4.1.2	Creating a bootable floppy disk.....	4-4
4.1.3	ASUS EZ Flash 2 utility.....	4-5
4.1.4	Updating the BIOS	4-6
4.1.5	Saving the current BIOS file.....	4-8
4.2	BIOS setup program	4-9
4.2.1	BIOS menu screen.....	4-10
4.2.2	Menu bar.....	4-10
4.2.3	Legend bar.....	4-11
4.2.4	Menu items	4-11
4.2.5	Sub-menu items.....	4-11
4.2.6	Configuration fields	4-11
4.2.7	Pop-up window	4-12
4.2.8	General help	4-12
4.3	Main menu	4-13
4.3.1	System Time	4-13

Contents

4.3.2	System Date	4-13
4.3.3	Language	4-13
4.3.4	Legacy Diskette A	4-13
4.3.5	Primary IDE Master/Slave.....	4-14
4.3.6	SATA 1 ~ 6.....	4-16
4.3.7	HDD SMART Monitoring.....	4-17
4.3.8	Installed Memory.....	4-17
4.3.9	Usable Memory	4-17
4.4	Extreme Tweaker menu	4-18
4.4.1	AI Tuning.....	4-18
4.4.2	Overclocking	4-21
4.4.3	Over Voltage	4-23
4.4.4	NVIDIA GPU Ex	4-24
4.4.5	SLI-Ready Memory	4-24
4.4.6	SLI-Ready Memory CPUOC	4-24
4.5	Advanced menu	4-25
4.5.1	AI NET2	4-25
4.5.2	PCIPnP	4-26
4.5.3	Onboard Device Configuration.....	4-27
4.6	Power menu.....	4-30
4.6.1	ACPI Suspend Type [S1&S3].....	4-30
4.6.2	ACPI APIC Support [Enabled].....	4-30
4.6.3	APM Configuration.....	4-31
4.6.4	Hardware Monitor	4-33
4.7	Boot menu	4-37
4.7.1	Boot Device Priority	4-37
4.7.2	Removable Drives.....	4-38
4.7.3	Hard Disk Drives	4-38
4.7.4	CDROM Drives	4-38
4.7.5	Boot Settings Configuration	4-39

Contents

4.7.6	Security	4-40
4.8	Tools menu	4-42
4.8.1	ASUS Music Alarm.....	4-42
4.8.2	ASUS O.C. Profile.....	4-43
4.8.3	ASUS EZ Flash 2.....	4-45
4.9	Exit menu	4-46

Chapter 5: Software support

5.1	Installing an operating system	5-1
5.2	Support CD information	5-1
5.2.1	Running the support CD	5-1
5.2.2	Drivers menu.....	5-2
5.2.3	Utilities menu	5-3
5.2.4	Make Disk menu	5-5
5.2.5	Manuals menu	5-6
5.2.6	ASUS Contact information	5-6
5.2.7	Other information	5-7
5.3	Software information	5-9
5.3.1	ASUS MyLogo3™	5-9
5.3.2	SoundMAX® High Definition Audio utility.....	5-11
5.3.3	ASUS PC Probe II.....	5-16
5.3.4	ASUS Music Alarm.....	5-22
5.3.5	ASUS Ai Booster	5-25
5.4	RAID configurations	5-26
5.4.1	RAID definitions	5-26
5.4.2	NVIDIA® RAID configurations.....	5-27
5.4.3	Silicon Image® RAID configurations	5-34
5.5	Creating a RAID driver disk.....	5-41

Chapter 6: NVIDIA® SLI™ technology support

6.1	Overview	6-1
6.2	Dual graphics card setup	6-2
6.2.1	Installing SLI-ready graphics cards.....	6-2
6.2.2	Installing the device drivers.....	6-5
6.2.3	Enabling the multi-GPU feature in Windows®	6-5

Notices

Federal Communications Commission Statement

This device complies with Part 15 of the FCC Rules. Operation is subject to the following two conditions:

- This device may not cause harmful interference, and
- This device must accept any interference received including interference that may cause undesired operation.

This equipment has been tested and found to comply with the limits for a Class B digital device, pursuant to Part 15 of the FCC Rules. These limits are designed to provide reasonable protection against harmful interference in a residential installation. This equipment generates, uses and can radiate radio frequency energy and, if not installed and used in accordance with manufacturer's instructions, may cause harmful interference to radio communications. However, there is no guarantee that interference will not occur in a particular installation. If this equipment does cause harmful interference to radio or television reception, which can be determined by turning the equipment off and on, the user is encouraged to try to correct the interference by one or more of the following measures:

- Reorient or relocate the receiving antenna.
- Increase the separation between the equipment and receiver.
- Connect the equipment to an outlet on a circuit different from that to which the receiver is connected.
- Consult the dealer or an experienced radio/TV technician for help.



The use of shielded cables for connection of the monitor to the graphics card is required to assure compliance with FCC regulations. Changes or modifications to this unit not expressly approved by the party responsible for compliance could void the user's authority to operate this equipment.

Canadian Department of Communications Statement

This digital apparatus does not exceed the Class B limits for radio noise emissions from digital apparatus set out in the Radio Interference Regulations of the Canadian Department of Communications.

This class B digital apparatus complies with Canadian ICES-003.

Safety information

Electrical safety

- To prevent electrical shock hazard, disconnect the power cable from the electrical outlet before relocating the system.
- When adding or removing devices to or from the system, ensure that the power cables for the devices are unplugged before the signal cables are connected. If possible, disconnect all power cables from the existing system before you add a device.
- Before connecting or removing signal cables from the motherboard, ensure that all power cables are unplugged.
- Seek professional assistance before using an adapter or extension cord. These devices could interrupt the grounding circuit.
- Make sure that your power supply is set to the correct voltage in your area. If you are not sure about the voltage of the electrical outlet you are using, contact your local power company.
- If the power supply is broken, do not try to fix it by yourself. Contact a qualified service technician or your retailer.

Operation safety

- Before installing the motherboard and adding devices on it, carefully read all the manuals that came with the package.
- Before using the product, make sure all cables are correctly connected and the power cables are not damaged. If you detect any damage, contact your dealer immediately.
- To avoid short circuits, keep paper clips, screws, and staples away from connectors, slots, sockets and circuitry.
- Avoid dust, humidity, and temperature extremes. Do not place the product in any area where it may become wet.
- Place the product on a stable surface.
- If you encounter technical problems with the product, contact a qualified service technician or your retailer.



This symbol of the crossed out wheeled bin indicates that the product (electrical and electronic equipment) should not be placed in municipal waste. Check local regulations for disposal of electronic products.

About this guide

This user guide contains the information you need when installing and configuring the motherboard.

How this guide is organized

This guide contains the following parts:

- **Chapter 1: Product introduction**
This chapter describes the features of the motherboard and the new technology it supports.
- **Chapter 2: Hardware information**
This chapter lists the hardware setup procedures that you have to perform when installing system components. It includes description of the jumpers and connectors on the motherboard.
- **Chapter 3: Powering up**
This chapter describes the power up sequence and ways of shutting down the system.
- **Chapter 4: BIOS setup**
This chapter tells how to change system settings through the BIOS Setup menus. Descriptions of the BIOS items are also provided.
- **Chapter 5: Software support**
This chapter describes the contents of the support CD that comes with the motherboard package.
- **Chapter 6: NVIDIA® SLI™ technology support**
This chapter tells how to install SLI-ready PCI Express graphics cards.

Where to find more information

Refer to the following sources for additional information and for product and software updates.

1. **ASUS websites**
The ASUS website provides updated information on ASUS hardware and software products. Refer to the ASUS contact information.
2. **Optional documentation**
Your product package may include optional documentation, such as warranty flyers, that may have been added by your dealer. These documents are not part of the standard package.

Conventions used in this guide

To make sure that you perform certain tasks properly, take note of the following symbols used throughout this manual.



DANGER/WARNING: Information to prevent injury to yourself when trying to complete a task.



CAUTION: Information to prevent damage to the components when trying to complete a task.



IMPORTANT: Instructions that you **MUST** follow to complete a task.



NOTE: Tips and additional information to help you complete a task.

Typography

Bold text

Indicates a menu or an item to select.

Italics

Used to emphasize a word or a phrase.

<Key>

Keys enclosed in the less-than and greater-than sign means that you must press the enclosed key.

Example: <Enter> means that you must press the Enter or Return key.

<Key1+Key2+Key3>

If you must press two or more keys simultaneously, the key names are linked with a plus sign (+).

Example: <Ctrl+Alt+D>

Command

Means that you must type the command exactly as shown, then supply the required item or value enclosed in brackets.

Example: At the DOS prompt, type the command line:

format A: /S

Striker Extreme specifications summary

CPU	<p>LGA775 socket for Intel® Core™2 Extreme / Core™2 Duo / Pentium® Extreme / Pentium® D / Pentium® 4 / Celeron® D Processors</p> <p>Intel® Quad-core CPU Ready</p> <p>Compatible with Intel® 06/05B/05A processors</p> <p>Note: Visit the ASUS website at www.asus.com for the Intel® CPU support list.</p>
Chipset	<p>NVIDIA® nForce 680i SLI</p> <ul style="list-style-type: none"> - Supports SLI-Ready Memory Technology
Front Side Bus	1333** / 1066 / 800 / 533 MHz
Memory	<p>Dual-channel memory architecture</p> <ul style="list-style-type: none"> - 4 x 240-pin DIMM sockets support non-ECC unbuffered DDR2 800/667/533 MHz memory modules - Supports up to 8 GB system memory <p>Note: Visit the ASUS website at www.asus.com for the latest Qualified Vendors List (QVL).</p>
SLI-Ready Memory	1200 MHz
Expansion slots	<p>2 x PCI Express™ x16 slots support NVIDIA® SLI™ technology at full x16, x16 speed (blue)</p> <p>1 x PCI Express™ 16, at x 8 speed (middle)</p> <p>1 x PCI Express™ x1</p> <p>2 x PCI 2.2</p>
Scalable Link Interface (SLI™)	<p>Supports two identical NVIDIA® SLI™-Ready graphics cards (both at x16 mode)</p> <p>Note: The blue PCI Express x 16 slots support NVIDIA® SLI™ technology at full x16, x16 speed. The middle slot is for an add-on card at x8 speed.</p>
Storage/RAID	<p>Southbridge supports:</p> <ul style="list-style-type: none"> - 1 x Ultra DMA 133/100/66/33 - 6 x Serial ATA 3.0 Gb/s - NVIDIA® MediaShield™ RAID supports RAID 0, 1, 0+1, 5 and JBOD configuration across Serial ATA drives <p>Silicon Image® 3132 SATA controller supports:</p> <ul style="list-style-type: none"> - 2 x External Serial ATA 3.0 Gb/s ports (SATA-on-the-Go) on the rear panel
LAN	<p>NVIDIA® nForce 680i SLI built-in dual Gigabit MAC with external Marvell PHY</p> <ul style="list-style-type: none"> - Supports NVIDIA® DualNet®a Technology

(continued on the next page)

Striker Extreme specifications summary

High Definition Audio	SupremeFX Audio Card <ul style="list-style-type: none"> - ADI 1988B 8-channel High Definition Audio CODEC - Supports Jack-Sensing, Enumeration, Multi-streaming and Jack-Retasking - Noise Filter Coaxial, Optical S/PDIF out DTS® Connect ASUS Array Mic
IEEE 1394	VIA6308P controller supports: <ul style="list-style-type: none"> - 2 x IEEE 1394a connectors (1 at mid-board, 1 on the rear panel)
USB	Supports up to 10 USB 2.0/1.1 ports (6 at mid-board, 4 on the rear panel)
ASUS Exclusive Overclocking features	Extreme Tweaker Intelligent overclocking tools: <ul style="list-style-type: none"> - AI NOS™ (Non-delay Overclocking System) - AI Overclocking (intelligent CPU frequency tuner) - AI Booster Overclocking protection: <ul style="list-style-type: none"> - ASUS C.P.R. (CPU Parameter Recall)
ASUS Unique features	LCD Poster EL I/O Onboard LED Onboard Switches: Power / Reset / Clr CMOS Q-Connector Q-Fan Plus ASUS EZ Flash 2 ASUS Music Alarm ASUS MyLogo 3
Rear panel	1 x LCD Poster 1 x PS/2 Keyboard port (purple) 1 x PS/2 Mouse (green) 1 x Optical S/PDIF Output port 1 x Coaxial S/PDIF Output port 2 x External Serial ATA ports 2 x LAN (RJ45) port 4 x USB 2.0/1.1 ports 1 x IEEE1394a port 1 x Onboard LED switch

(continued on the next page)

Striker Extreme specifications summary

Internal connectors	<ul style="list-style-type: none"> 1 x Floppy disk drive connector 1 x IDE connector for 2 devices 6 x Serial ATA connectors 3 x USB 2.0 connectors support six additional USB 2.0 ports 1 x IEEE 1394a port connector 1 x Chassis intrusion connector 1 x 24-pin ATX power connector 1 x 8-pin ATX 12V power connector 1 x S/PDIF output connector 3 x thermal sensor connectors 8 x Fan connectors: 1 x CPU / 1 x Power / 1 x Chassis / 5 x optional fan connectors 1 x EL I/O Shield connector System panel connector
BIOS features	8 Mb AWARD BIOS, PnP, DMI2.0, WfM2.0, SM BIOS 2.3, Multi-Language BIOS
Manageability	WOL by PME, WOR by PME, Chasis Intrusion, PXE
Accessories	<ul style="list-style-type: none"> SLI bridge ASUS Array Mic ASUS optional fan ASUS Q-connector Kit UltraDMA 133/100/66 cable Floppy disk drive cable SATA cables SATA power cables Thermal sensor cables Cable ties 2-port USB2.0 module IEEE1394a module EL I/O Shield ROG key ring InterVideo® Media Launcher (OEM version only) User's manual
Support DVD contents	<ul style="list-style-type: none"> The hottest 3D game: Ghost Recon Device drivers ASUS PC Probe II ASUS Update ASUS AI Booster Futuremark® 3DMark® 06 Advanced Edition Kaspersky® Anti-virus NVIDIA® MediaShield™ RAID
Form factor	ATX form factor: 12 in x 9.6 in (30.5 cm x 24.5 cm)

*Specifications are subject to change without notice.

** available when the installed CPU is supporting 1333MHz FSB.

This chapter describes the motherboard features and the new technologies it supports.

1 Product introduction

Chapter summary



- 1.1 Welcome! 1-1
- 1.2 Package contents..... 1-1
- 1.3 Special features..... 1-2

1.1 Welcome!

Thank you for buying an ASUS® Striker Extreme motherboard!

The motherboard delivers a host of new features and latest technologies, making it another standout in the long line of ASUS quality motherboards!

Before you start installing the motherboard, and hardware devices on it, check the items in your package with the list below.

1.2 Package contents

Check your motherboard package for the following items.

Motherboard	ASUS Striker Extreme motherboard
I/O modules	1 x 1-port IEEE 1394a module 1 x 2-port USB 2.0 module
Cables	Serial ATA power and signal cables for 6 devices 1 x Ultra DMA 133/100/66 cable 1 x Floppy disk drive cable 3 x Thermal sensor cables Cable ties
Accessories	I/O shield with EL 1 x ROG key ring ASUS Array Mic 1 x ASUS Optional Fan 1 x 3-in-1 ASUS Q-Connector Kit (USB, IEEE 1394, system panel; Retail version only) 1 x ASUS SLI Bridge
Application DVD	ASUS motherboard support CD/DVD InterVideo® Media Launcher (OEM version) 3D Game-Ghost Recon Advanced Warfighter
Documentation	User guide



If any of the above items is damaged or missing, contact your retailer.

1.3 Special features

1.3.1 Product highlights

Republic of Gamers

The Republic of Gamers consists only the best of the best. We offer the best hardware engineering, the fastest performance, the most innovating ideas, and we welcome the best gamers to join in.

In the Republic of Gamers, mercy rules are only for the weak, and bragging rights means everything. We believe in making statements and we excel in competitions. If your character matches our trait, then join the elite club, make your presence felt, in the Republic of Gamers.

Green ASUS

This motherboard and its packaging comply with the European Union's Restriction on the use of Hazardous Substances (RoHS). This is in line with the ASUS vision of creating environment-friendly and recyclable products/packaging to safeguard consumers' health while minimizing the impact on the environment.

Intel® Core™2 / Quad-core Processor Ready



This motherboard supports the latest Intel® Core™2 processor in the LGA775 package. With the new Intel® Core™ microarchitecture technology and 1066 / 800 MHz FSB, the Intel® Core™2 is one of the most powerful and energy efficient CPUs in the world. This motherboard also supports the latest Intel® Quad-core processor, which is excellent for multi-tasking, multi-media and enthusiastic gamers with 1066 / 800 MHz FSB. See page 2-7 for details.

NVIDIA® nForce® 680i SLI chipset

The NVIDIA® nForce 680i SLI chipset supports the NVIDIA® Scalable Link Interface (SLI™) technology that allows two graphics processing units (GPUs) in a single system. It's designed for enthusiast, extreme overclocking capability, ultimate gaming performance with SLI technology support. It's definitely one of the fastest platform in the world. See Chapter 6 for details. The NVIDIA® nForce 680i SLI chipset also supports six (6) Serial ATA 3.0 Gb/s devices, dual PCI Express™ x16 slots at with NVIDIA® SLI™ support at full x16, x16 mode, and up to 10 USB 2.0 ports.

NVIDIA® Scalable Link Interface (SLI™)



NVIDIA SLI™ (Scalable Link Interface) takes advantage of the increased bandwidth of the PCI Express bus architecture and features intelligent hardware and software that allows two GPUs to efficiently work together to deliver earth-shattering, scalable performance.



DDR2 memory support

The motherboard supports DDR2 memory that features data transfer rates of 800/667/533 MHz to meet the higher bandwidth requirements of the latest 3D graphics, multimedia, and Internet applications. The dual-channel DDR2 architecture doubles the bandwidth of your system memory to boost system performance, eliminating bottlenecks with peak bandwidths of up to 12.8 GB/s. See page 2-15 for details.

Serial ATA /I/I technology and SATA-On-The-Go



The motherboard fully supports the Serial ATA II 3.0 Gb/s technology through the Serial ATA interfaces and the NVIDIA® nForce® 680i SLI™ chipset. The Serial ATA 3.0 Gb/s specification provides twice the bandwidth of the current Serial ATA products with a host of new features, including Native Command Queuing (NCQ), and Power Management (PM) Implementation Algorithm. Serial ATA allows for thinner, more flexible cables with lower pin count and reduced voltage required. See page 2-27 for details.

Leveraging these Serial ATA 3.0 Gb/s features is the SATA-On-The-Go. Supported by the Silicon Image® 3132 Serial ATA controller are two external Serial ATA 3.0 Gb/s ports on the rear panel that provide smart setup and hot-plug function. See page 2-24 for details.

Dual RAID solution



Onboard RAID controllers provide the motherboard with dual-RAID functionality that allows you to select the best RAID solution for Serial ATA devices.

The NVIDIA® MediaShield™ RAID controller integrated in the NVIDIA® nForce® 680i SLI™ chipset allows RAID 0, RAID 1, RAID 0+1, RAID 5, and JBOD configurations for six SATA 3.0 Gb/s connectors. See pages 2-30 and 5-27 for details.

The Silicon Image® 3132 controller supports two additional external Serial ATA 3.0 Gb/s ports on the rear panel and allows RAID 0, RAID 1, and JBOD configurations through port multiplier functions. See page 5-34 for details.

IEEE 1394a support



The IEEE 1394a interface provides high speed digital interface for audio/video appliances such as digital television, digital video camcorders, storage peripherals & other PC portable devices. See pages 2-25 and 2-29 for details.

S/PDIF digital sound ready

This motherboard provides convenient connectivity to external home theater audio systems via coaxial and optical S/PDIF-out (SONY/PHILIPS Digital Interface) jacks. It allows to transfer digital audio without converting to analog format and keeps the best signal quality. See pages 2-23, 2-25 and 2-28 for details.

Dual Gigabit LAN solution



The motherboard comes with dual Gigabit LAN controllers to provide the total solution for your networking needs. These network controllers use the PCI Express segment to provide faster data bandwidth for your wired or wireless Internet, LAN, and file sharing requirements. See page 2-23 for details.

1.3.2 ASUS unique features

8-phase cap-less Power design



The 8-phase EL Capless Power Design demonstrates two hardcore commitments of ROG products: ultimate overclocking capability, and ultimate reliability. The 8-phase power design yields unparalleled superiority in the overclocking arena, while the cap-less design removes any worries of capacitor problems once and for all.

Fanless Design



The ASUS fanless design allows multi-directional heat flow from major thermal sources in the motherboard to lower overall system temperature, resulting in quieter operation and longer system life. ASUS has devoted special efforts to address the thermal issues across the motherboard, and most notably in the following areas: CPU, power, VGA, Northbridge and Southbridge. The heat pipe, heatsink, and strategic board layout were tailor made to dissipate heat in the most efficient manner.

AI NOS™ (Non-Delay Overclocking System)



ASUS Non-delay Overclocking System™ (NOS) is a technology that auto-detects the CPU loading and dynamically overclocks the CPU speed only when needed. See page 4-18 for details.

Extreme Tweaker



This feature allows you to fine tune the CPU/memory voltage and gradually increase the memory Front Side Bus (FSB) and PCI Express frequency at 1MHz increment to achieve maximum system performance.

ASUS Q-Connector



The ASUS Q-Connector allows you to connect or disconnect chassis front panel cables in one easy step. This unique adapter eliminates the trouble of plugging in one cable at a time, making connection quick and error-free. See pages 2-36 for details.

ASUS LCD Poster

The LCD Poster displays actual boot error messages instead of codes that other debug cards show. This unique feature allows you to easily find out which devices fail during the boot process, eliminating guesswork and allowing you to solve the problem immediately.

Onboard LEDs

This motherboard features onboard LEDs located near connector labels, allowing you to connect cables and devices without a flashlight. With this ASUS-patented feature, you can easily identify connector locations to make sure that cables and devices are plugged in and installed correctly.

Onboard Switches

A power-on button, a reset button, and a clear CMOS button are onboard to provide overclockers and gamers the convenience of fine-tuning performance when working on a bare (open-case) system. Press the power-on button to wake up the system, the reset button to reboot, and the clear CMOS button to clear setup information when the system hangs due to overclocking. See page 2-37 for details.

ASUS Q-Fan plus technology

The ASUS Q-Fan plus technology smartly adjusts the CPU and chassis fan 1 speeds according to the system loading to ensure quiet, cool, and efficient operation. See page 4-35 for details.

ASUS Multi-language BIOS

The multi-language BIOS allows you to select the language of your choice from the available options. The localized BIOS menus allow easier and faster configuration. See page 4-13 for details.

ASUS MyLogo3

This new feature present in the motherboard allows you to personalize and add style to your system with customizable boot logos. See page 5-9 for details.

C.P.R. (CPU Parameter Recall)



The C.P.R. feature of the motherboard BIOS allows automatic re-setting to the BIOS default settings in case the system hangs due to overclocking. When the system hangs due to overclocking, C.P.R. eliminates the need to open the system chassis and clear the RTC data. Simply shut down and reboot the system, and the BIOS automatically restores the CPU default setting for each parameter.

ASUS Music Alarm



Wake up to the music of your choice instead of the irritating sound of an alarm clock. The ASUS Music Alarm gives you a personal wake-up call with your favorite CD music without having to enter the OS. See pages 4-42 and 5-22 for details.

Supreme FX features



This feature can enhance speech-centric applications like Skype, online game, video conference and recording.

ASUS Array Mic



The Bundled Superbeam Array Microphone receives only the sound coming from the reception cone and ignores the sounds coming from other directions. This mechanism eliminates a large number of interferences, including neighboring speakers and reverberations. It also uses advanced de-reverberation techniques to reduce echo and minimize its effect on the speech engine. This feature can enhance speech-centric applications like Skype, online game, video conference, and recording. See page 5-15 for details.

Noise Filter



This feature detects repetitive and stationary noises (non-voice signals) like computer fans, air conditioners, and other background noises then eliminates it in the incoming audio stream while recording. See page 5-15 for details.

DTS® Connect



This feature consists of two elements: DTS interactive and DTS NEO:PC. DTS interactive re-encodes your stereo or multi-channel sound into a DTS audio signal and send it out from your PC to any DTS enabled system. While DTS NEO:PC turns your stereo audio such as MP3, WMA, CD, and other sound format into a convincing multi-channel audio experience. See page 5-14 for details.

This chapter lists the hardware setup procedures that you have to perform when installing system components. It includes description of the jumpers and connectors on the motherboard.

Hardware ² information

2.1	Before you proceed	2-1
2.2	Motherboard overview.....	2-2
2.3	Central Processing Unit (CPU)	2-7
2.4	System memory	2-15
2.5	Expansion slots.....	2-18
2.6	Jumper	2-21
2.7	Audio Card and EL I/O Installation	2-22
2.8	Connectors	2-23

2.1 Before you proceed

Take note of the following precautions before you install motherboard components or change any motherboard settings.



- Use a grounded wrist strap or touch a safely grounded object or to a metal object, such as the power supply case, before handling components to avoid damaging them due to static electricity.
- Hold components by the edges to avoid touching the ICs on them.
- Whenever you uninstall any component, place it on a grounded antistatic pad or in the bag that came with the component.

Onboard LED

Blue lights strategically located beside key motherboard connectors allow you to install components conveniently, even without a flashlight.



Before you install or remove any component, make sure to press the onboard LED switch first and the standby power LED is off. Failure to do so may cause injury or severe damage to the motherboard, peripherals, and/or components.

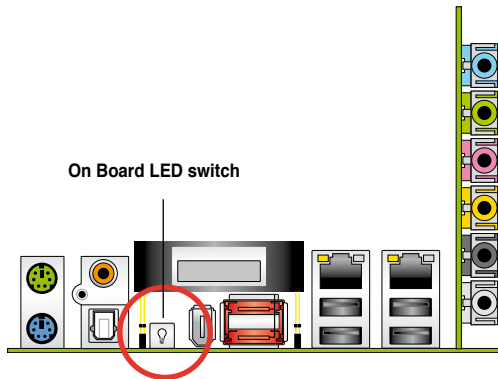

2.2 Motherboard overview

Before you install the motherboard, study the configuration of your chassis to ensure that the motherboard fits into it.



Make sure to unplug the power cord before installing or removing the motherboard. Failure to do so can cause you physical injury and damage motherboard components.

2.2.1 Placement direction

When installing the motherboard, make sure that you place it into the chassis in the correct orientation. The edge with external ports goes to the rear part of the chassis as indicated in the image below.

2.2.2 Screw holes

Place nine (9) screws into the holes indicated by circles to secure the motherboard to the chassis.



Do not overtighten the screws! Doing so can damage the motherboard.

Place this side towards the rear of the chassis

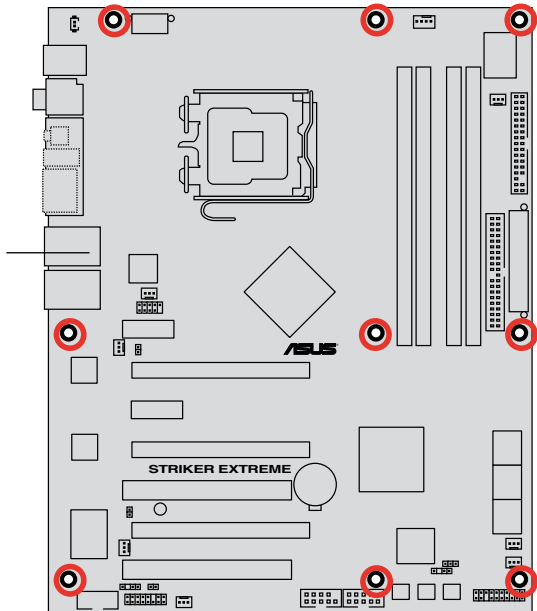

2.2.3 ASUS Stack Cool 2

The motherboard comes with the ASUS Stack Cool 2 cooling solution that lowers the temperature of critical heat generating components. The motherboard uses a special design on the printed circuit board (PCB) to dissipate heat that critical components generate.



2.2.4 Motherboard layout

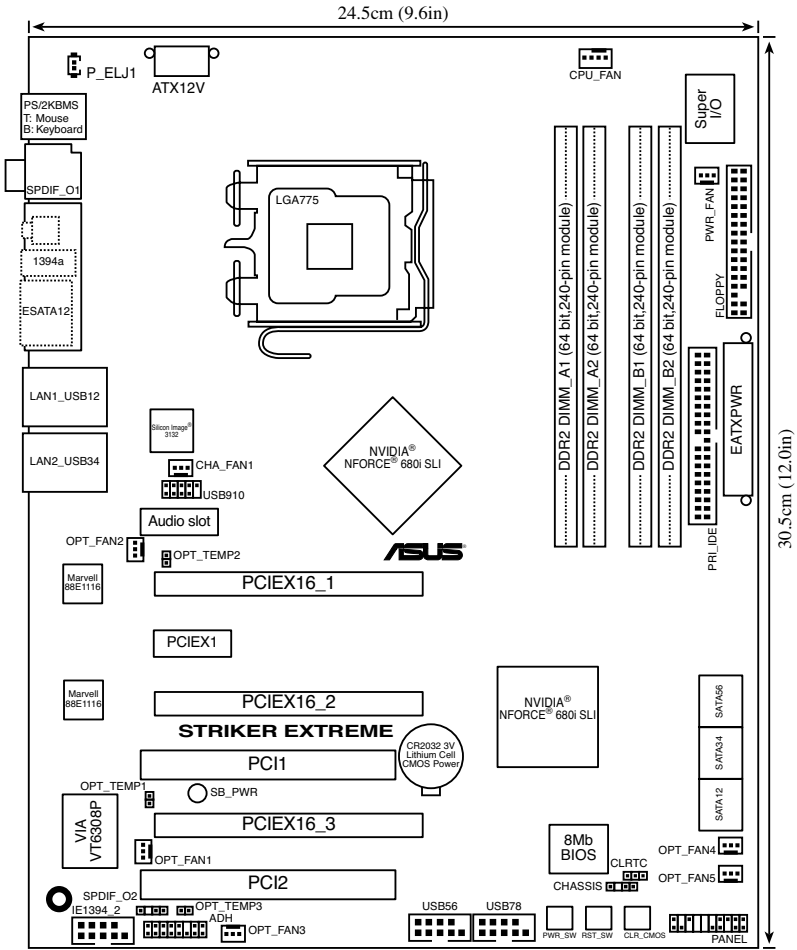

2.2.5 Layout contents

Slots		Page
1.	DDR2 DIMM slots	2-15
2.	PCI slots	2-20
3.	PCI Express x1 slot	2-20
4.	PCI Express x16 slots	2-20

Jumper		Page
1.	Clear RTC RAM (3-pin CLRTC_EN)	2-21

Rear panel connectors		Page
1.	PS/2 mouse port (green)	2-23
2.	Coaxial S/PDIF Out port	2-23
3.	LCD Poster	2-23
4.	IEEE 1394a port	2-25
5.	External SATA ports	2-24
6.	LAN 2 (RJ-45) port.	2-23
7.	LAN 1 (RJ-45) port	2-23
8.	USB 2.0 ports 1 and 2, 3 and 4	2-24
9.	Optical S/PDIF Out port	2-25
10.	PS/2 keyboard port (purple)	2-23

Supreme FX		Page
1.	Line In port (light blue)	2-24
2.	Line Out port (lime)	2-24
3.	Microphone port (pink)	2-24
4.	Center/Subwoofer port (orange)	2-24
5.	Side Speaker Out port (gray)	2-24
6.	Rear Speaker Out port (black)	2-24

Internal connectors		Page
1.	Floppy disk drive connector (34-1 pin FLOPPY)	2-26
2.	IDE connector (40-1 pin PRI_IDE)	2-26
3.	Serial ATA connectors (7-pin SATA1, SATA2, SATA3, SATA4, SATA5, SATA6)	2-27
4.	USB connectors (10-1 pin USB56, USB 78, USB910)	2-28
5.	IEEE 1394a port connector (10-1 pin IE1394_2)	2-29
6.	CPU, chassis, and power fan connectors (4-pin CPU_FAN, 3-pin CHA_FAN1, 3-pin OPT-FAN 1~5, 3-pin PWR_FAN)	2-30
7.	Chassis intrusion connector (4-1 pin CHASSIS)	2-31
8.	ATX power connectors (24-pin EATXPWR, 1 x 8-pin ATX12V)	2-31
9.	S/PDIF output connector (4-1 pin SPDIF_02)	2-34
10.	System panel connector (20-8-pin PANEL) <ul style="list-style-type: none"> • System power LED (2-pin PLED) • Hard disk drive activity LED (2-pin IDE_LED) • System warning speaker (4-pin SPEAKER) • ATX power button/soft-off button (2-pin PWR) • Reset button (2-pin RESET) 	2-35
	ASUS Q-connector (system panel)	2-36
11.	Thermal sensor cable connectors	2-37

Onboard switches		Page
1.	Clear CMOS switch	2-37
2.	Power-on switch	2-38
3.	Reset switch	2-38

2.3 Central Processing Unit (CPU)

The motherboard comes with a surface mount LGA775 socket designed for the Intel® Quad-core / Core™2 Extreme / Core™2 Duo / Pentium® Extreme / Pentium® D / Pentium® 4 and Celeron® D processors.



-
- Make sure that all power cables are unplugged before installing the CPU.
 - Connect the chassis fan cable to the CHA_FAN1 connector to ensure system stability.
-



-
- Upon purchase of the motherboard, make sure that the PnP cap is on the socket and the socket contacts are not bent. Contact your retailer immediately if the PnP cap is missing, or if you see any damage to the PnP cap/socket contacts/motherboard components. ASUS will shoulder the cost of repair only if the damage is shipment/transit-related.
 - Keep the cap after installing the motherboard. ASUS will process Return Merchandise Authorization (RMA) requests only if the motherboard comes with the cap on the LGA775 socket.
 - The product warranty does not cover damage to the socket contacts resulting from incorrect CPU installation/removal, or misplacement/loss/incorrect removal of the PnP cap.
-

2.3.1 Installing the CPU

To install a CPU:

1. Locate the CPU socket on the motherboard.

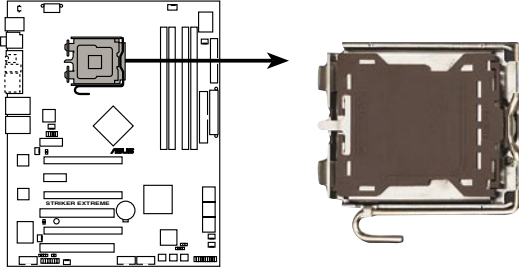

STRIKER EXTREME CPU Socket 775



Before installing the CPU, make sure that the socket box is facing towards you and the load lever is on your left.

2. Press the load lever with your thumb (A), then move it to the left (B) until it is released from the retention tab.

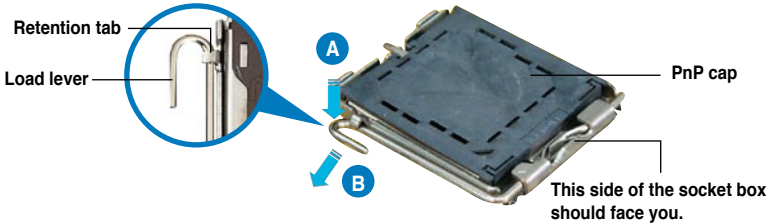

To prevent damage to the socket pins, do not remove the PnP cap unless you are installing a CPU.

3. Lift the load lever in the direction of the arrow to a 135° angle.

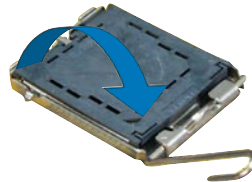

- Lift the load plate with your thumb and forefinger to a 100° angle (A), then push the PnP cap from the load plate window to remove (B).

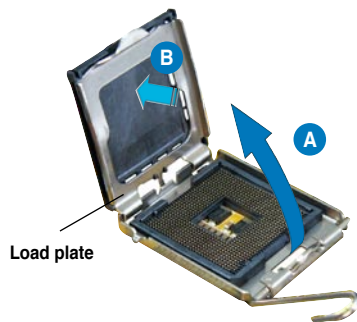

- Position the CPU over the socket, making sure that the gold triangle is on the bottom-left corner of the socket then fit the socket alignment key into the CPU notch.

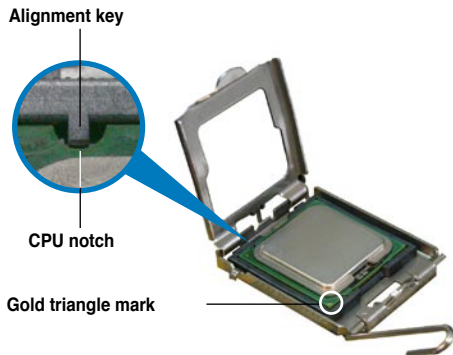

The CPU fits in only one correct orientation. DO NOT force the CPU into the socket to prevent bending the connectors on the socket and damaging the CPU!

- Close the load plate (A), then push the load lever (B) until it snaps into the retention tab.
- If installing a dual-core CPU, connect the chassis fan cable to the CHA_FAN1 connector to ensure system stability.



The motherboard supports Intel® LGA775 processors with the Intel® Enhanced Memory 64 Technology (EM64T), Enhanced Intel SpeedStep® Technology (EIST), and Hyper-Threading Technology. Refer to the Appendix for more information on these CPU features.

2.3.2 Installing the CPU heatsink and fan

The Intel® LGA775 processor requires a specially designed heatsink and fan assembly to ensure optimum thermal condition and performance.



- When you buy a boxed Intel® processor, the package includes the CPU fan and heatsink assembly. If you buy a CPU separately, make sure that you use only Intel®-certified multi-directional heatsink and fan.
- Your Intel® LGA775 heatsink and fan assembly comes in a push-pin design and requires no tool to install.
- If you purchased a separate CPU heatsink and fan assembly, make sure that you have properly applied Thermal Interface Material to the CPU heatsink or CPU before you install the heatsink and fan assembly.



Make sure that you have installed the motherboard to the chassis before you install the CPU fan and heatsink assembly.

To install the CPU heatsink and fan:

1. Place the heatsink on top of the installed CPU, making sure that the four fasteners match the holes on the motherboard.



Orient the heatsink and fan assembly such that the CPU fan cable is closest to the CPU fan connector.

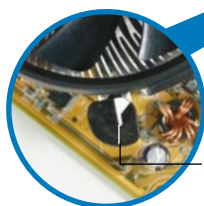

Narrow end
of the groove

Fastener

Motherboard hole



Make sure to orient each fastener with the narrow end of the groove pointing outward. (The photo shows the groove shaded for emphasis.)

2. Push down two fasteners at a time in a diagonal sequence to secure the heatsink and fan assembly in place.

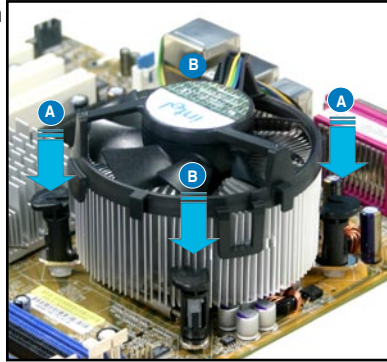
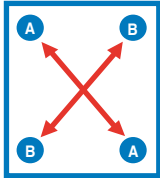

3. Connect the CPU fan cable to the connector on the motherboard labeled CPU_FAN.

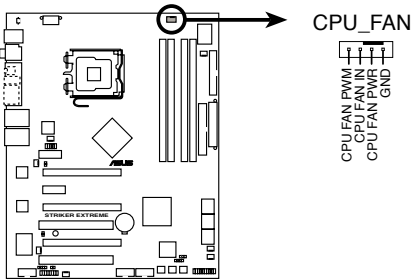

STRIKER EXTREME CPU fan connector



Do not forget to connect the CPU fan connector! Hardware monitoring errors can occur if you fail to plug this connector.

2.3.3 Uninstalling the CPU heatsink and fan

To uninstall the CPU heatsink and fan:

1. Disconnect the CPU fan cable from the connector on the motherboard.
2. Rotate each fastener counterclockwise.

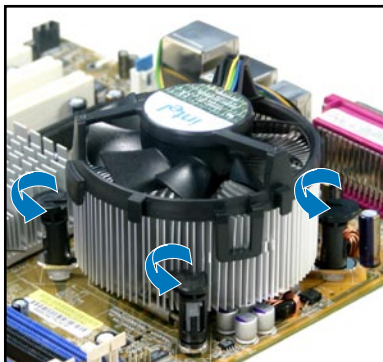

3. Pull up two fasteners at a time in a diagonal sequence to disengage the heatsink and fan assembly from the motherboard.

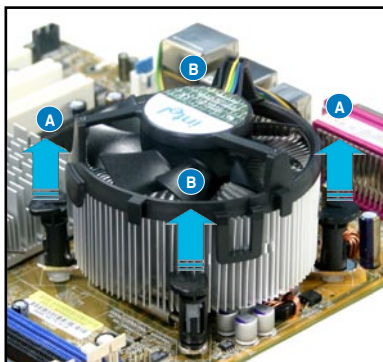
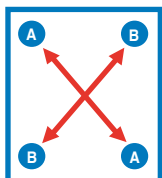

4. Carefully remove the heatsink and fan assembly from the motherboard.



5. Rotate each fastener clockwise to ensure correct orientation when reinstalling.



Narrow end of the groove



The narrow end of the groove should point outward after resetting. (The photo shows the groove shaded for emphasis.)



Refer to the documentation in the boxed or stand-alone CPU fan package for detailed information on CPU fan installation.

2.3.4 Installing the optional fan



Install the optional fan only if you are using a passive cooler or a water cooler. Installing the optional fan with an active CPU cooler will interfere with the airflow and destabilize the system.

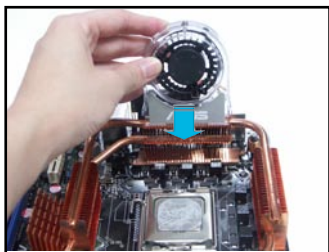

1. Position the fan above the pipe and heatsink assembly.



2. Fit the grooved edge to the heatsink.



3. Carefully push down the fan until it snugly fits the heatsink, then connect the fan cables.

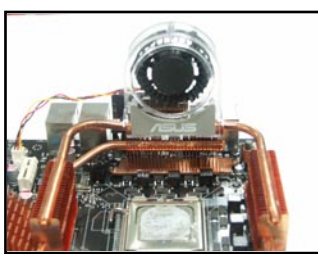

4. The above photo shows the fan installed on the motherboard.



- Plug the optional fan cables to any of the OPT FAN1~5 connectors on the motherboard.
- Make sure the optional fan is installed correctly to prevent damage to the fan and motherboard components.

2.4 System memory

2.4.1 Overview

The motherboard comes with four Double Data Rate 2 (DDR2) Dual Inline Memory Modules (DIMM) sockets.

A DDR2 module has the same physical dimensions as a DDR DIMM but has a 240-pin footprint compared to the 184-pin DDR DIMM. DDR2 DIMMs are notched differently to prevent installation on a DDR DIMM socket.

The figure illustrates the location of the DDR2 DIMM sockets:

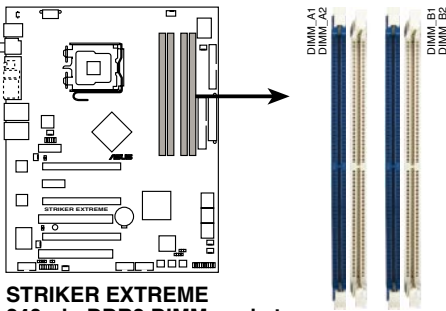

Channel	Sockets
Channel A	DIMM_A1 and DIMM_A2
Channel B	DIMM_B1 and DIMM_B2

2.4.2 Memory configurations

You may install 256 MB, 512 MB, 1 GB, and 2 GB unbuffered non-ECC DDR2 DIMMs into the DIMM sockets.



- For dual-channel configuration, the total size of memory module(s) installed per channel must be the same (DIMM_A1 + DIMM_A2 = DIMM_B1 + DIMM_B2).
- Always install DIMMs with the same CAS latency. For optimum compatibility, we recommend that you obtain memory modules from the same vendor. Visit the ASUS website at www.asus.com for the latest DDR2 Qualified Vendors List.
- Due to chipset resource allocation, the system may detect less than 32 GB system memory when you installed four 8 GB DDR2 memory modules.



- The motherboard can support up to 32 GB on the operating system listed below. You may install a maximum of 8 GB DIMMs on each slot.

32-bit	64-bit
Windows® 2000 Advanced Server	Windows® Server 2003 Standard x64 Edition
Windows® Server 2003 Enterprise Edition	Windows® XP Professional x64 Edition
	Windows® Server 2003 Enterprise x64 Edition



Visit the ASUS website for the latest DDR2-800/667/533 MHz QVL.

2.4.3 Installing a DIMM



Unplug the power supply before adding or removing DIMMs or other system components. Failure to do so can cause severe damage to both the motherboard and the components.

To install a DIMM:

1. Unlock a DIMM socket by pressing the retaining clips outward.
2. Align a DIMM on the socket such that the notch on the DIMM matches the break on the socket.
3. Firmly insert the DIMM into the socket until the retaining clips snap back in place and the DIMM is properly seated.

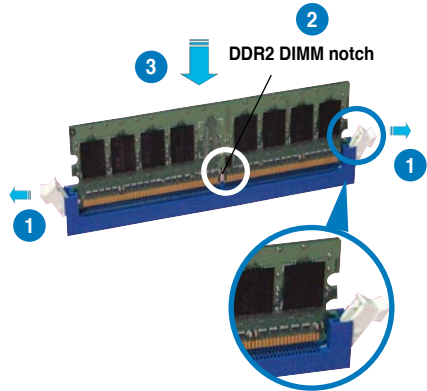

Unlocked retaining clip



- A DDR2 DIMM is keyed with a notch so that it fits in only one direction. Do not force a DIMM into a socket to avoid damaging the DIMM.
- The DDR2 DIMM sockets do not support DDR DIMMs. Do not install DDR DIMMs to the DDR2 DIMM sockets.

2.4.4 Removing a DIMM

To remove a DIMM:

1. Simultaneously press the retaining clips outward to unlock the DIMM.



Support the DIMM lightly with your fingers when pressing the retaining clips. The DIMM might get damaged when it flips out with extra force.

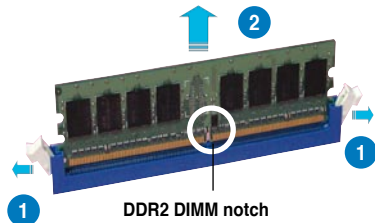

2. Remove the DIMM from the socket.

2.5 Expansion slots

In the future, you may need to install expansion cards. The following sub-sections describe the slots and the expansion cards that they support.



Make sure to unplug the power cord before adding or removing expansion cards. Failure to do so may cause you physical injury and damage motherboard components.

2.5.1 Installing an expansion card

To install an expansion card:

1. Before installing the expansion card, read the documentation that came with it and make the necessary hardware settings for the card.
2. Remove the system unit cover (if your motherboard is already installed in a chassis).
3. Remove the bracket opposite the slot that you intend to use. Keep the screw for later use.
4. Align the card connector with the slot and press firmly until the card is completely seated on the slot.
5. Secure the card to the chassis with the screw you removed earlier.
6. Replace the system cover.

2.5.2 Configuring an expansion card

After installing the expansion card, configure it by adjusting the software settings.

1. Turn on the system and change the necessary BIOS settings, if any. See Chapter 4 for information on BIOS setup.
2. Assign an IRQ to the card. Refer to the tables on the next page.
3. Install the software drivers for the expansion card.



When using PCI cards on shared slots, ensure that the drivers support “Share IRQ” or that the cards do not need IRQ assignments. Otherwise, conflicts will arise between the two PCI groups, making the system unstable and the card inoperable. Refer to the table on the next page for details.

2.5.3 Interrupt assignments

IRQ	Standard function
0	System timer
1	Standard 101/102-key or Microsoft Natural Keyboard
4	Communications Port (COM1)*
6	Standard floppy disk controller
8	System CMOS/real-time clock
9	Microsoft ACPI-compliant system
9	NVIDIA nForce networking controller #3
9	NVIDIA nForce networking controller #4
10	NVIDIA nForce PCI system management
11	Mass storage controller
12	PS/2 compatible mouse port
13	Numeric data processor
14	Primary IDE channel
16	NVIDIA GeForce 6600 GT
19	VIA OHCI compliant IEEE 1394 host controller
20	NVIDIA nForce 590/570/550 Serial ATA controller
20	NVIDIA network bus enumerator
21	NVIDIA network bus enumerator
22	Standard OpenHCD USB host controller
22	NVIDIA nForce 590/570/550 Serial ATA controller
23	Standard Enhanced PCI to USB host controller
23	NVIDIA nForce 590/570/550 Serial ATA controller

IRQ assignments for this motherboard

	A	B	C	D	E	F	G	H
PCIEx16_1	-	-	-	-	shared	-	-	-
PCIEx16_2	-	-	-	-	-	shared	-	-
PCIEx16_3	-	-	-	-	shared	-	-	-
PCIEx1_1	-	-	-	-	-	shared	-	-
PCI Slot_1	shared	-	-	-	-	-	-	-
PCI Slot_2	-	shared	-	-	-	-	-	-
USB 1.1	-	shared	-	-	-	-	-	-
USB 2.0	-	-	shared	-	-	-	-	-
LAN_1	-	shared	-	-	-	-	-	-
LAN_2	-	shared	-	-	-	-	-	-
PATA	shared	-	-	-	-	-	-	-
SATA_1	-	shared	-	-	-	-	-	-
SATA_2	-	-	shared	-	-	-	-	-
SATA_3	-	-	-	used	-	-	-	-
SATA_RAID	-	shared	-	-	-	-	-	-
1394	-	shared	-	-	-	-	-	-
Audio	-	-	shared	-	-	-	-	-

2.5.4 PCI slots

The PCI slots support cards such as a LAN card, SCSI card, USB card, and other cards that comply with PCI specifications. Refer to the figure below for the location of the slots.

2.5.5 PCI Express x1 slot

This motherboard supports PCI Express x1 network cards, SCSI cards and other cards that comply with the PCI Express specifications. Refer to the figure below for the location of the slot.

2.5.6 PCI Express x16 slots

This motherboard has three PCI Express x16 slots that support PCI Express x16 graphic cards complying with the PCI Express specifications. Refer to the figure below for the location of the slots.

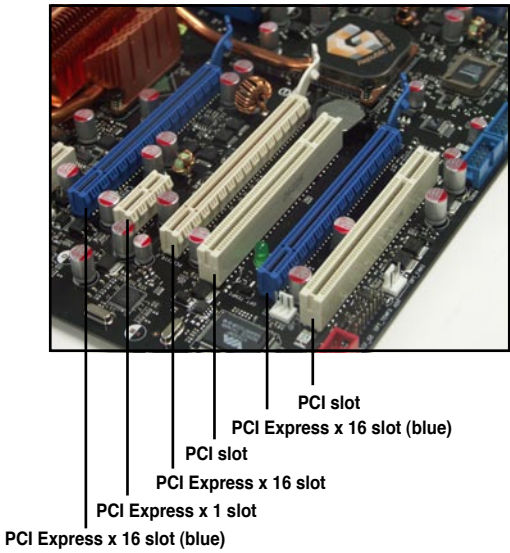

2.6 Jumper

Clear RTC RAM (CLRTC)

This jumper allows you to enable the CLRTC switch. You can clear the CMOS memory of date, time, and system setup parameters by erasing the CMOS RTC RAM data. The onboard clr CMOS switch helps you easily to clear the system setup information such as system passwords. See page 2-35 for details.

To erase the RTC RAM:

1. Turn OFF the computer and unplug the power cord.
2. Move the jumper cap from pins 1-2 (default) to pins 2-3 to enable the CLRTC function.
3. Press down the **clr CMOS** button and again to release it.
4. Plug the power cord and turn ON the computer.
5. Hold down the key during the boot process and enter BIOS setup to re-enter data.



The **clr CMOS** button will not function until the jumper cap on CLRTC is moved to the **ENABLE** position. Removing the cap will cause system boot failure!

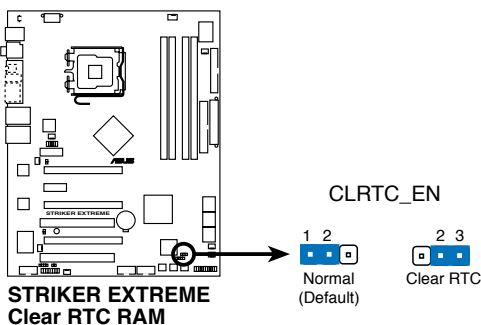

- Make sure to re-enter your previous BIOS settings after you clear the CMOS.
- You do not need to clear the RTC when the system hangs due to overclocking. For system failure due to overclocking, use the C.P.R. (CPU Parameter Recall) feature. Shut down and reboot the system so the BIOS can automatically reset parameter settings to default values.
- To prevent accidental pressing of the Clear CMOS switch, the CLRTC jumper default setting disables the switch.

2.7 Audio Card and EL I/O Installation

2.7.1 Audio Card Installation



1. Take out the Audio card from the package.



2. Locate the slot on the motherboard.



3. Align the card connector with the slot and press firmly until the card sits on the slot completely.



4. The above photo shows the audio card installed on the motherboard.

2.7.2 EL I/O Installation



1. Take out the EL I/O from the package.

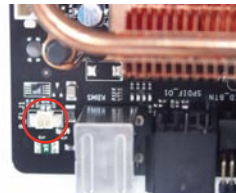

2. Locate the connector on the motherboard.



3. Connect the cable to the connector in a correct orientation.



4. The above photo shows the EL I/O installed on the motherboard.

2.8 Connectors

2.8.1 Rear panel connectors

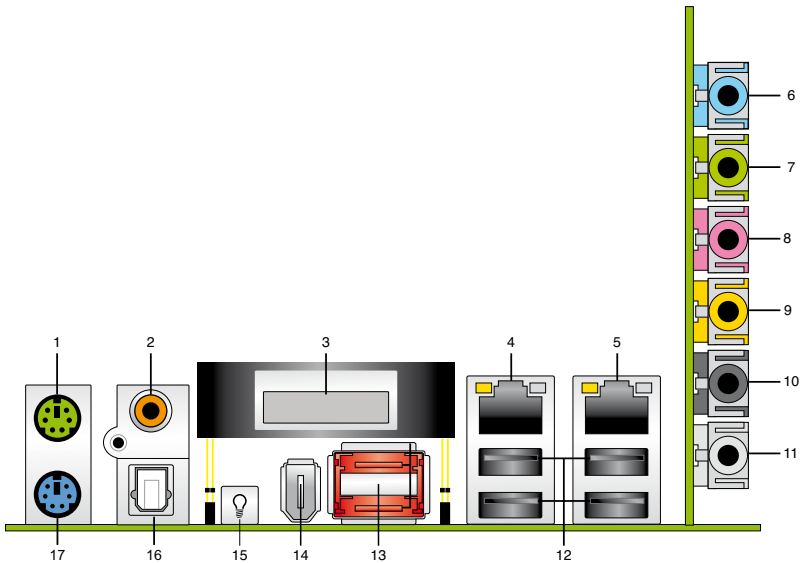

1. **PS/2 mouse port (green).** This port is for a PS/2 mouse.
2. **Coaxial S/PDIF Out port.** This port connects an external audio output device via an optical S/PDIF cable.
3. **LCD Poster.** This poster displays actual boot error messages.
4. **LAN 1 (RJ-45) port.** Supported by NV Gigabit LAN controller, this port allows Gigabit connection to a Local Area Network (LAN) through a network hub. Refer to the table on the next page for the LAN port LED indications.
5. **LAN 2 (RJ-45) port.** Supported by the NV Gigabit LAN controller, this port allows Gigabit connection to a Local Area Network (LAN) through a network hub. Refer to the table below for the LAN port LED indications.

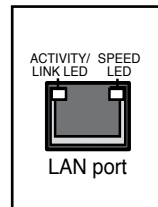

32-bit OS LAN port LED indications

Activity/Link	Speed LED	Description
OFF	OFF	Soft-off Mode
YELLOW*	OFF	During Power ON/OFF
YELLOW*	ORANGE	100 Mbps connection

* Blinking

64-bit OS LAN port LED indications

Activity/Link	Speed LED	Description
DNR	DNR	Soft-off Mode
DNR	DNR	During Power ON/OFF
DNR	DNR	100 Mbps connection
DNR	DNR	1 Gbps connection

- Line In port (light blue).** This port connects the tape, CD, DVD player, or other audio sources.
- Line Out port (lime).** This port connects a headphone or a speaker. In 4-channel, 6-channel, and 8-channel configuration, the function of this port becomes Front Speaker Out.
- Microphone port (pink).** This port connects a microphone.
- Center/Subwoofer port (orange).** This port connects the center/subwoofer speakers.
- Rear Speaker Out port (black).** This port connects the rear speakers on a 4-channel, 6-channel, or 8-channel audio configuration.
- Side Speaker Out port (gray).** This port connects the side speakers in an 8-channel audio configuration.



Refer to the audio configuration table below for the function of the audio ports in 2, 4, 6, or 8-channel configuration.

Audio 2, 4, 6, or 8-channel configuration

Port	Headset 2-channel	4-channel	6-channel	8-channel
Light Blue	Line In	Line In	Line In	Line In
Lime	Line Out	Front Speaker Out	Front Speaker Out	Front Speaker Out
Pink	Mic In	Mic In	Mic In	Mic In
Orange	–	–	Center/Subwoofer	Center/Subwoofer
Black	–	Rear Speaker Out	Rear Speaker Ou	Rear Speaker Out
Gray	–	–	–	Side Speaker Out

- USB 2.0 ports 1 and 2, 3 and 4.** These 4-pin Universal Serial Bus (USB) ports are available for connecting USB 2.0 devices.
- External SATA ports.** These ports connect to an external SATA box or a Serial ATA port multiplier. These ports support a Serial ATA hard disk drive that you can combine with an external Serial ATA 3.0 Gb/s device to configure a RAID 0, RAID 1, or JBOD set through the onboard Silicon Image® SATA RAID controller. Refer to Chapter 5 for details on how to set up Serial ATA RAID configurations.



-
- Before creating a RAID set using Serial ATA hard disks, make sure that you have connected the Serial ATA signal cable and installed Serial ATA hard disk drives; otherwise, you cannot enter the Silicon Image RAID utility and SATA BIOS setup during POST.
 - The external SATA ports support external Serial ATA 1.5 and 3 Gb/s devices. Longer cables support higher power requirements to deliver signal up to two meters away, and enables improved hot-swap function.
 - If you intend to create a RAID configuration using this connector, set the **Silicon SATAII Controller** item in the BIOS to **[RAID Mode]**. See section “4.5.3 Onboard Device Configuration” for details.
 - Use these ports and an external Serial ATA box connected to the external SATA port, if you want to configure a RAID 0 or RAID 1 set.
 - The Serial ATA port multiplier and external Serial ATA box are purchased separately.
-



-
- DO NOT insert a different connector to this port.
 - DO NOT unplug the external Serial ATA box when a RAID 0 or RAID 1 is configured.
-

14. **IEEE 1394a port.** This 6-pin IEEE 1394a port provides high-speed connectivity for audio/video devices, storage peripherals, PCs, or portable devices.
15. **Onboard LED switch.** This motherboard features onboard LEDs that light up the labels, making it easy for you to install or plug in devices even in the dark. Press this switch to turn on the onboard LEDs.
16. **Optical S/PDIF Out port.** This port connects an external audio output device via an optical S/PDIF cable.
17. **PS/2 keyboard port (purple).** This port is for a PS/2 keyboard.

2.8.2 Internal connectors

1. Floppy disk drive connector (34-1 pin FLOPPY)

This connector is for the provided floppy disk drive (FDD) signal cable. Insert one end of the cable to this connector, then connect the other end to the signal connector at the back of the floppy disk drive.



Pin 5 on the connector is removed to prevent incorrect cable connection when using a FDD cable with a covered Pin 5.

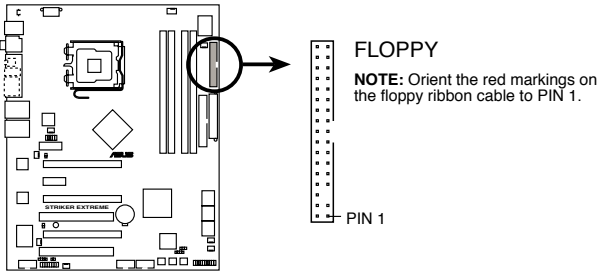

STRIKER EXTREME Floppy disk drive connector

2. IDE connector (40-1 pin PRI_IDE)

The onboard IDE connector is for the Ultra DMA 133/100/66 signal cable. There are three connectors on each Ultra DMA 133/100/66 signal cable: blue, black, and gray. Connect the blue connector to the motherboard's IDE connector, then select one of the following modes to configure your device.

	Drive jumper setting	Mode of device(s)	Cable connector
Single device	Cable-Select or Master	-	Black
Two devices	Cable-Select	Master	Black
		Slave	Gray
	Master	Master	Black or gray
	Slave	Slave	



- Pin 20 on the IDE connector is removed to match the covered hole on the Ultra DMA cable connector. This prevents incorrect insertion when you connect the IDE cable.
- Use the 80-conductor IDE cable for Ultra DMA 133/100/66 IDE devices.



If any device jumper is set as "Cable-Select," make sure all other device jumpers have the same setting.

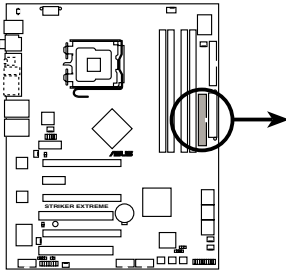

PRI_IDE
NOTE: Orient the red markings (usually zigzag) on the IDE ribbon cable to PIN 1.

STRIKER EXTREME IDE connector

3. Serial ATA connectors (7-pin SATA1, SATA2, SATA3, SATA4, SATA5, SATA6)

These connectors are for the Serial ATA signal cables for Serial ATA hard disk drives.

If you installed Serial ATA hard disk drives, you can create a RAID 0, RAID 1, RAID 0+1, RAID 5, or JBOD configuration with the onboard NVIDIA® MediaShield™ RAID controller.



The RAID function of these connectors is set to [Disabled] by default. If you intend to create a Serial ATA RAID set using these connectors, enable the **RAID Enabled** item under the **Serial ATA Configuration** sub-menu in the BIOS. See section “4.5.3 Onboard Device Configuration” for details.

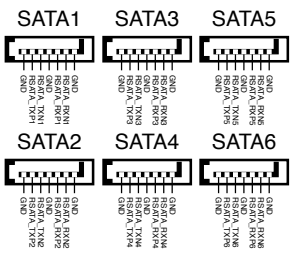
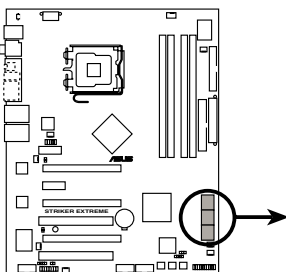

STRIKER EXTREME SATA connectors



These connectors support Native Command Queuing (NCQ), Power Management (PM) Implementation Algorithm, Hot Swap and smart setup.



Connect the right-angle side of SATA signal cable to the SATA device, or connect the right-angle side of the SATA cable to the onboard SATA port to avoid mechanical conflict with huge graphics cards.

Right-angle side

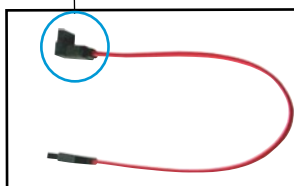

4. USB connectors (10-1 pin USB56, USB78, USB910)

These connectors are for USB 2.0 ports. Connect the USB module cable to any of these connectors, then install the module to a slot opening at the back of the system chassis. These USB connectors comply with USB 2.0 specification that supports up to 480 Mbps connection speed.

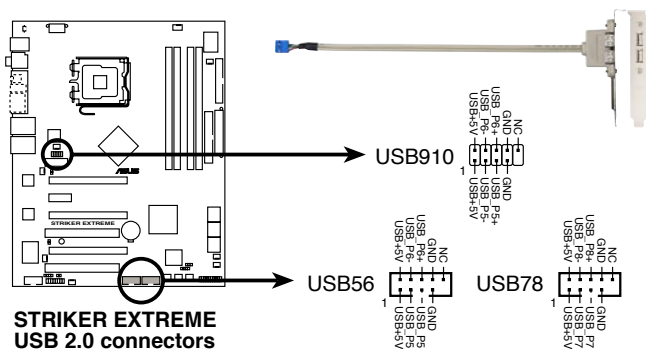

Never connect a 1394 cable to the USB connectors. Doing so will damage the motherboard!



You can connect the USB cable to ASUS Q-Connector (USB, blue) first, and then install the Q-Connector (USB) to the USB connector onboard.

5. IEEE 1394a port connector (10-1 pin IE1394_2)

This connector is for a IEEE 1394a port. Connect the IEEE 1394a module cable to this connector, then install the module to a slot opening at the back of the system chassis.

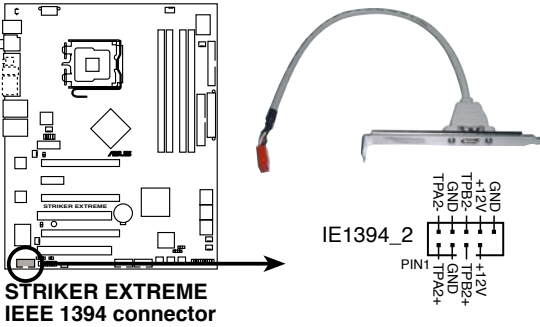

Never connect a USB cable to the IEEE 1394a connector. Doing so will damage the motherboard!



You can connect the 1394 cable to ASUS Q-Connector (1394, red) first, and then install the Q-Connector (1394) to the 1394 connector onboard.

6. CPU, chassis, power, and optional fan connectors (4-pin CPU_FAN, 3-pin CHA_FAN1, 3-pin PWR_FAN, 3-pin OPT_FAN1~5)

The fan connectors support cooling fans of 350 mA ~ 2000 mA (24 W max.) or a total of 1 A ~ 7 A (84 W max.) at +12V. Connect the fan cables to the fan connectors on the motherboard, making sure that the black wire of each cable matches the ground pin of the connector.



Do not forget to connect the fan cables to the fan connectors. Insufficient air flow inside the system may damage the motherboard components. These are not jumpers! Do not place jumper caps on the fan connectors!

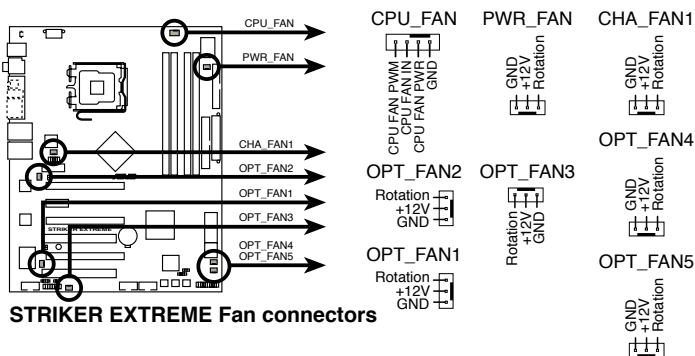

- Only the CHA_FAN1 and OPT_FAN 1~3 connectors support the ASUS Q-FAN 2 feature.
- If you install two VGA cards, we recommend that you plug the rear chassis fan cable to the motherboard connector labeled OPT_FAN1 or OPT_FAN2 for better thermal environment.

7. Chassis intrusion connector (4-1 pin CHASSIS)

This connector is for a chassis-mounted intrusion detection sensor or switch. Connect one end of the chassis intrusion sensor or switch cable to this connector. The chassis intrusion sensor or switch sends a high-level signal to this connector when a chassis component is removed or replaced. The signal is then generated as a chassis intrusion event.

By default, the pin labeled “Chassis Signal” and “Ground” are shorted with a jumper cap. Remove the jumper caps only when you intend to use the chassis intrusion detection feature.

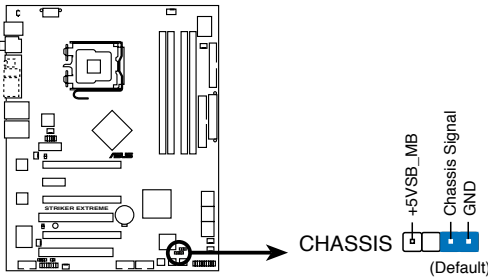

STRIKER EXTREME Chassis intrusion connector

8. ATX power connectors (24-pin EATXPWR, 2 x 4-pin ATX12V)

These connectors are for ATX power supply plugs. The power supply plugs are designed to fit these connectors in only one orientation. Find the proper orientation and push down firmly until the connectors completely fit.

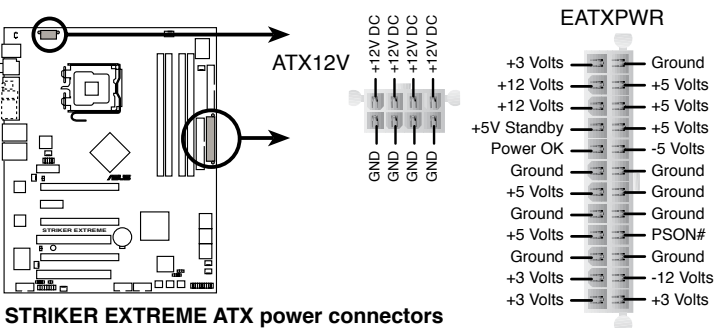

STRIKER EXTREME ATX power connectors



- Make sure to remove the cap on the ATX12V connector before connecting an 8-pin EPS +12V power plug.
- Use only either a 4-pin ATX12V or an 8-pin EPS +12V power plug for the ATX12V connector.



- For a fully configured system, we recommend that you use a power supply unit (PSU) that complies with ATX 12 V Specification 2.0 (or later version) and provides a minimum power of 550 W.
- Do not forget to connect the 4-pin/8pin EATX12V power plug; otherwise, the system will not boot.
- Use of a PSU with a higher power output is recommended when configuring a system with more power-consuming devices. The system may become unstable or may not boot up if the power is inadequate.
- If you want to use two high-end PCI Express x16 cards, use a PSU with 500 W to 600 W power or above to ensure the system stability.

Power supply requirements

Heavy Loading	
CPU	SMF 3.2XE
DDR533	256MB*4
PCI-E VGA	Nvidia 7950GTX*2
SATA-HD	6
ESATA-HD	2
IDE-HD	1
CD-ROM	1
USB	2
PCI-E 1X	0
PCI	0

	+12V-V2 (4 PIN)	+12V-V1 (24PIN)	+5V	+3.3V	VGA +12V	HDD +12V	HDD +5V	+5VSB	Total PSU
Io_max (A)	17	11.4	5.66	9.18	15.76	7.6	7.96	0.548	Po_max (W)
Io_rms (A)	12.35	7.68	4.42	8.52	10.74	3.32	5.26	0.413	
Vout (V)	11.93	11.9	5.022	3.316	11.42	11.95			
Po_max (W)	202.81	135.66	28.42	30.44	179.98	90.82	4.993	5.054	

(continued on the next page)

Power supply requirements

Normal Loading	
CPU	PSC 3.73G 1066
DDR800	1GB*2
VGA	Nvidia 7800GTX*2
SATA-HD	SATA*4
ESATA-HD	1
IDE-HD	1
CD-ROM	1
USB	2
PCI	1

	+12V-V2 (4 PIN)	+12V-V1 (24PIN)	+5V	+3.3V	VGA +12V	HDD +12V	HDD +5V	+5VSB	Total PSU
Io_max (A)	12.72	11.44	6.88	8.72	8.88	4.04	4.14	0.588	Po_max (W)
Io_rms (A)	9.16	8.1	5.6	8	5.86	2.14	2.92	0.435	
Vout (V)	11.94	11.9	5.026	3.32	11.57	11.99	5.04	5.05	
Po_max (W)	151.88	136.14	34.58	28.95	102.74	48.44	20.87	2.97	

Light Loading	
CPU	PSC 3.8G EM64T
DDR667	512MB*2
VGA	Nvidia 7800GTX*1
SATA-HD	SATA*2
IDE-HD	1
CD-ROM	1
USB	1
PCI	1

	+12V-V2 (4 PIN)	+12V-V1 (24PIN)	+5V	+3.3V	VGA +12V	HDD +12V	HDD +5V	+5VSB	Total PSU
Io_max (A)	12.36	7.6	8.44	3.24	4.28	4.34	3.58	0.556	Po_max (W)
Io_rms (A)	8.98	4.8	6.76	3.01	2.84	23.4	2.48	0.396	
Vout (V)	11.93	11.93	5.026	3.33	11.91	12.03	5.09	5.066	
Po_max (W)	147.45	90.67	42.42	10.79	50.97	52.21	18.22	2.82	

9. S/PDIF output connector (4-1 pin SPDIF_O2)

This connector is for an additional Sony/Philips Digital Interface (S/PDIF) port(s). Connect the S/PDIF Out module cable to this connector, then install the module to a slot opening at the back of the system chassis.

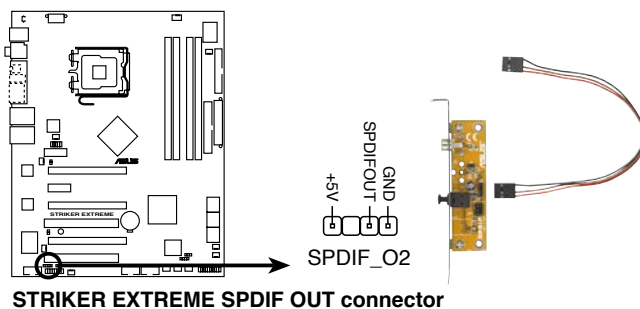

The S/PDIF module is purchased separately.

10. System panel connector (20-8 pin PANEL)

This connector supports several chassis-mounted functions.

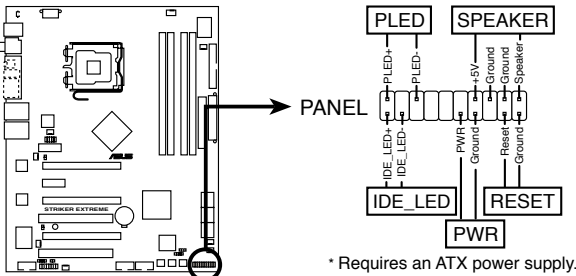

STRIKER EXTREME System panel connector

- **System power LED (2-pin PLED)**

This 2-pin connector is for the system power LED. Connect the chassis power LED cable to this connector. The system power LED lights up when you turn on the system power, and blinks when the system is in sleep mode.

- **Hard disk drive activity LED (2-pin IDE_LED)**

This 2-pin connector is for the HDD Activity LED. Connect the HDD Activity LED cable to this connector. The IDE LED lights up or flashes when data is read from or written to the HDD.

- **System warning speaker (4-pin SPEAKER)**

This 4-pin connector is for the chassis-mounted system warning speaker. The speaker allows you to hear system beeps and warnings.

- **ATX power button/soft-off button (2-pin PWR)**

This connector is for the system power button. Pressing the power button turns the system on or puts the system in sleep or soft-off mode depending on the BIOS settings. Pressing the power switch for more than four seconds while the system is ON turns the system OFF.

- **Reset button (2-pin RESET)**

This 2-pin connector is for the chassis-mounted reset button for system reboot without turning off the system power.

ASUS Q-Connector (system panel)

You can use the ASUS Q-Connector to connect/disconnect chassis front panel cables in a few steps. Refer to the instructions below to install the ASUS Q-Connector.

1. Connect the front panel cables to the ASUS Q-Connector.
Refer to the labels on the Q-Connector to know the detailed pin definitions, then match them to the respective front panel cable labels.

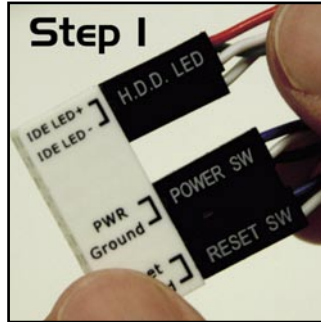

2. Install the ASUS Q-Connector to the system panel connector, making sure the orientation matches the labels on the motherboard.

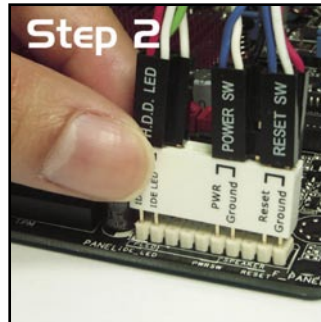

3. The front panel functions are now enabled. The figure shows the Q-Connector properly installed on the motherboard.

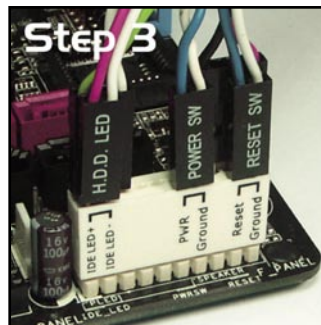

11. Thermal sensor cable connectors (2-pin OPT_TEMP1/2/3)

These connectors are for temperature monitoring. Connect the thermal sensor cables to these connectors and place the other ends to the devices, which you want to monitor temperature. The optional fan1~3 can work with the temperature sensors for a better cooling effect.

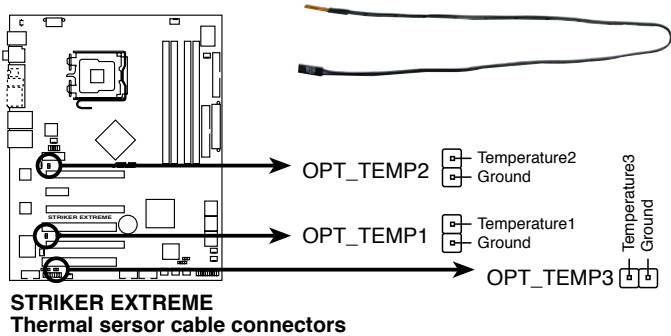

2.8.3 Onboard switches

Onboard switches allow you to fine-tune performance when working on a bare or open-case system. This is ideal for overclockers and gamers who continually change settings to enhance system performance.

1. Clear CMOS switch

Press the clear CMOS switch to clear setup information when the system hangs due to overclocking.

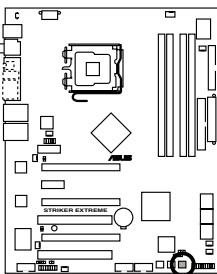

STRIKER EXTREME CMOS switch



To prevent accidental pressing of the Clear CMOS switch, the CLRTC jumper default setting disables the switch. See page 2-21 for details.

2. Power-on switch

Press the clear power-on switch to wake/power up the system.

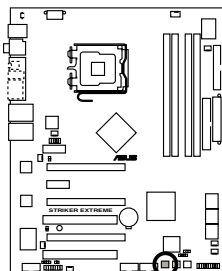

STRIKER EXTREME Power on switch

3. Reset switch

Press the reset switch to reboot the system.

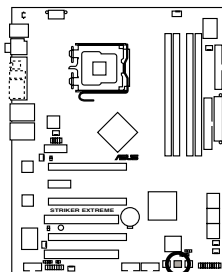

STRIKER EXTREME Reset switch

This chapter describes the power up sequence, the vocal POST messages, and ways of shutting down the system.

Powering up **3**

Chapter summary

3

3.1	Starting up for the first time.....	3-1
3.2	Turning off the computer.....	3-2

3.1 Starting up for the first time

1. After making all the connections, replace the system case cover.
2. Be sure that all switches are off.
3. Connect the power cord to the power connector at the back of the system chassis.
4. Connect the power cord to a power outlet that is equipped with a surge protector.
5. Turn on the devices in the following order:
 - a. Monitor
 - b. External SCSI devices (starting with the last device on the chain)
 - c. System power
6. After applying power, the system power LED on the system front panel case lights up. For systems with ATX power supplies, the system LED lights up when you press the ATX power button. If your monitor complies with “green” standards or if it has a “power standby” feature, the monitor LED may light up or switch between orange and green after the system LED turns on.

The system then runs the power-on self tests or POST. While the tests are running, the BIOS beeps (see BIOS beep codes table below) or additional messages appear on the screen. If you do not see anything within 30 seconds from the time you turned on the power, the system may have failed a power-on test. Check the jumper settings and connections or call your retailer for assistance.
7. At power on, hold down the <Delete> key to enter the BIOS Setup. Follow the instructions in Chapter 4.

3.2 Turning off the computer

3.2.1 Using the OS shut down function

If you are using Windows® 2000:

1. Click the Start button then click Shut Down...
2. Make sure that the Shut Down option button is selected, then click the OK button to shut down the computer.
3. The power supply should turn off after Windows® shuts down.

If you are using Windows® XP or later version:

1. Click the Start button then select Turn Off Computer.
2. Click the Turn Off button to shut down the computer.
3. The power supply should turn off after Windows® shuts down.

3.2.2 Using the dual function power switch

While the system is ON, pressing the power switch for less than four seconds puts the system to sleep mode or to soft-off mode, depending on the BIOS setting. Pressing the power switch for more than four seconds lets the system enter the soft-off mode regardless of the BIOS setting. Refer to section “4.6 Power Menu” in Chapter 4 for details.

This chapter tells how to change the system settings through the BIOS Setup menus. Detailed descriptions of the BIOS parameters are also provided.

BIOS setup **4**

4.1	Managing and updating your BIOS	4-1
4.2	BIOS setup program	4-9
4.3	Main menu	4-15
4.4	Extreme Tweaker menu	4-18
4.5	Advanced menu	4-25
4.6	Power menu	4-30
4.7	Boot menu	4-37
4.8	Tools menu	4-42
4.9	Exit menu	4-46

4.1 Managing and updating your BIOS

The following utilities allow you to manage and update the motherboard Basic Input/Output System (BIOS) setup.

1. **ASUS Update** (Updates the BIOS in Windows® environment.)
2. **ASUS EZ Flash 2** (Updates the BIOS in DOS using a floppy disk or a USB flash disk.)
3. **Award BIOS Flash Utility** (Updates the BIOS in DOS mode using a bootable floppy disk.)

Refer to the corresponding sections for details on these utilities.



Save a copy of the original motherboard BIOS file to a bootable floppy disk in case you need to restore the BIOS in the future. Copy the original motherboard BIOS using the ASUS Update or Award BIOS Flash utilities.

4.1.1 ASUS Update utility

The ASUS Update is a utility that allows you to manage, save, and update the motherboard BIOS in Windows® environment. The ASUS Update utility allows you to:

- Save the current BIOS file
- Download the latest BIOS file from the Internet
- Update the BIOS from an updated BIOS file
- Update the BIOS directly from the Internet, and
- View the BIOS version information.

This utility is available in the support DVD that comes with the motherboard package.



ASUS Update requires an Internet connection either through a network or an Internet Service Provider (ISP).

Installing ASUS Update

To install ASUS Update:

1. Place the support DVD in the optical drive. The Drivers menu appears.
2. Click the Utilities tab, then click Install ASUS Update VX.XX.XX. See page 5-3 for the Utilities screen menu.
3. The ASUS Update utility is copied to your system.



Quit all Windows® applications before you update the BIOS using this utility.

Updating the BIOS through the Internet

To update the BIOS through the Internet:

1. Launch the ASUS Update utility from the Windows® desktop by clicking **Start > Programs > ASUS > ASUSUpdate > ASUSUpdate**. The ASUS Update main window appears.

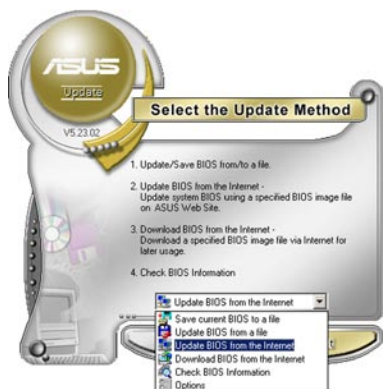
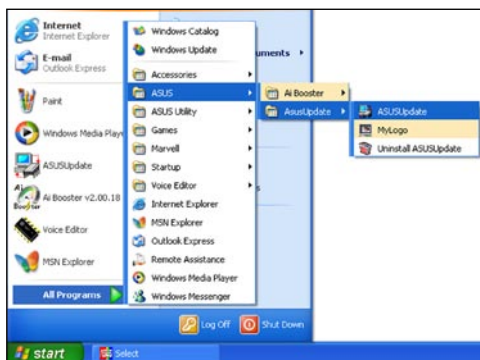

2. Select **Update BIOS** from the Internet option from the drop-down menu, then click **Next**.



3. Select the ASUS FTP site nearest you to avoid network traffic, or click **Auto Select**. Click **Next**.

- From the FTP site, select the BIOS version that you wish to download. Click **Next**.
- Follow the screen instructions to complete the update process.



The ASUS Update utility is capable of updating itself through the Internet. Always update the utility to avail all its features.



Updating the BIOS through a BIOS file

To update the BIOS through a BIOS file:

- Launch the ASUS Update utility from the Windows® desktop by clicking **Start > Programs > ASUS > ASUSUpdate > ASUSUpdate**. The ASUS Update main window appears.
- Select Update BIOS from a file option from the drop-down menu, then click **Next**.

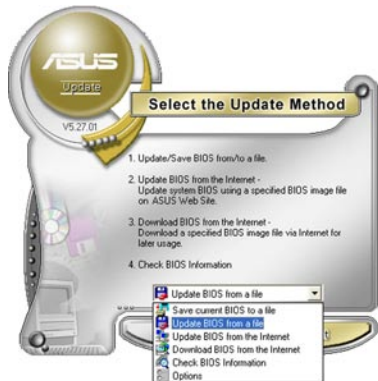

- Locate the BIOS file from the Open window, then click **Open**.
- Follow the screen instructions to complete the update process.

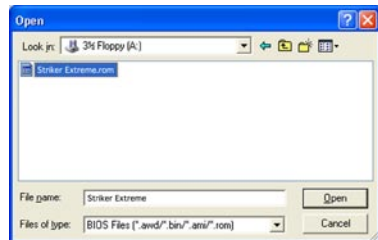

4.1.2 Creating a bootable floppy disk

1. Do either one of the following to create a bootable floppy disk.

DOS environment

- a. Insert a 1.44MB floppy disk into the drive.
- b. At the DOS prompt, type `format A: /s` then press <Enter>.

Windows® XP environment

- a. Insert a 1.44 MB floppy disk to the floppy disk drive.
- b. Click **Start** from the Windows® desktop, then select **My Computer**.
- c. Select the 3 1/2 Floppy Drive icon.
- d. Click File from the menu, then select **Format. A Format 3 1/2 Floppy Disk** window appears.
- e. Select **Create an MS-DOS startup disk** from the format options field, then click **Start**.

Windows® 2000 environment

To create a set of boot disks for Windows® 2000:

- a. Insert a formatted, high density 1.44 MB floppy disk into the drive.
- b. Insert the Windows® 2000 CD to the optical drive.
- c. Click **Start**, then select **Run**.
- d. From the Open field, type
`D:\bootdisk\makeboot a:`
assuming that D: is your optical drive.
- e. Press <Enter>, then follow screen instructions to continue.

2. Copy the original or the latest motherboard BIOS file to the bootable floppy disk.

4.1.3 ASUS EZ Flash 2 utility

The ASUS EZ Flash 2 feature allows you to update the BIOS without having to go through the long process of booting from a floppy disk and using a DOS-based utility. The EZ Flash utility is built-in the BIOS chip so it is accessible by pressing <Alt> + <F2> during the Power-On Self Tests (POST).

To update the BIOS using EZ Flash 2:

1. Visit the ASUS website (www.asus.com) to download the latest BIOS file for the motherboard.
2. Save the BIOS file to a floppy disk, then restart the system.
3. You can launch the EZ Flash 2 by two methods.

(1) Insert the floppy disk/USB flash disk that contains the BIOS file to the floppy disk drive or the USB port.

Press <Alt> + <F2> during POST to display the following.



(2) Enter BIOS setup program. Go to the Tools menu to select EZ Flash 2 and press <Enter> to enable it.

You can switch between drives by pressing <Tab> before the correct file is found. Then press <Enter>.

4. When the correct BIOS file is found, EZ Flash 2 performs the BIOS update process and automatically reboots the system when down.



- This function can support devices such as USB flash disk, hard disk, or floppy disk with FAT32/16/12 format only.
- Do not shut down or reset the system while updating the BIOS to prevent system boot failure!

4.1.4 Updating the BIOS

The Basic Input/Output System (BIOS) can be updated using the AwardBIOS Flash Utility. Follow these instructions to update the BIOS using this utility.

1. Download the latest BIOS file from the ASUS web site. Unzip the file and save it to a floppy disk.



Save only the updated BIOS file in the floppy disk to avoid loading the wrong BIOS file.

2. Copy the AwardBIOS Flash Utility (awdfash.exe) from the Software folder of the support DVD to the floppy disk with the latest BIOS file.
3. Boot the system in DOS mode using the bootable floppy disk you created earlier.
4. When the A:> appears, replace the bootable floppy disk with the floppy disk containing the new BIOS file and the Award BIOS Flash Utility.
5. At the prompt, type awdfash then press <Enter>. The Award BIOS Flash Utility screen appears.

```
AwardBIOS Flash Utility for ASUS V1.18
(C) Phoenix Technologies Ltd. All Rights Reserved

For C55XEMCP55PXE-StrikerE-00      DATE:10/30/2006
Flash Type - Unknown Flash

File Name to Program: 

Message: Please input File Name!
```

6. Type the BIOS file name in the File Name to Program field, then press <Enter>.

```
AwardBIOS Flash Utility for ASUS V1.18
(C) Phoenix Technologies Ltd. All Rights Reserved

For C55XEMCP55PXE-StrikerE-00      DATE:10/30/2006
Flash Type - Unknown Flash

File Name to Program: 0113.bin

Message: Do You Want To Save Bios (Y/N)
```

7. Press <N> when the utility prompts you to save the current BIOS file. The following screen appears.
8. The utility verifies the BIOS file in the floppy disk and starts flashing the BIOS file.

```
AwardBIOS Flash Utility for ASUS V1.18
(C) Phoenix Technologies Ltd. All Rights Reserved
For C55XEMCP55PXE-StrikerE-00      DATE:10/30/2006
Flash Type - Unknown Flash

File Name to Program: 0116.bin

Programming Flash Memory - OFE00 OK

Write OK      No Update      Write Fail

Warning: Don't Turn Off Power Or Reset System!
```



Do not turn off or reset the system during the flashing process!

9. The utility displays a Flashing Complete message indicating that you have successfully flashed the BIOS file. Remove the floppy disk then press <F1> to restart the system.

```
AwardBIOS Flash Utility for ASUS V1.18
(C) Phoenix Technologies Ltd. All Rights Reserved
For C55XEMCP55PXE-StrikerE-00      DATE:10/30/2006
Flash Type - Unknown Flash

File Name to Program: 0116.bin
Flashing Complete
Press <F1> to Continue

Write OK      No Update      Write Fail

F1 Reset
```

4.1.5 Saving the current BIOS file

You can use the AwardBIOS Flash Utility to save the current BIOS file. You can load the current BIOS file when the BIOS file gets corrupted during the flashing process.



Make sure that the floppy disk has enough disk space to save the file.

To save the current BIOS file using the AwardBIOS Flash Utility:

1. Follow steps 1 to 6 of the previous section.
2. Press <Y> when the utility prompts you to save the current BIOS file. The following screen appears.

```
AwardBIOS Flash Utility for ASUS V1.18
(C) Phoenix Technologies Ltd. All Rights Reserved

For C55XEMCP55PXE-StrikerE-00    DATE:10/30/2006
Flash Type - Unknown Flash

File Name to Program: 0116.bin
Save current BIOS as:

Message:
```

3. Type a filename for the current BIOS file in the Save current BIOS as field, then press <Enter>.

```
AwardBIOS Flash Utility for ASUS V1.18
(C) Phoenix Technologies Ltd. All Rights Reserved

For C55XEMCP55PXE-StrikerE-00    DATE:10/30/2006
Flash Type - Unknown Flash

File Name to Program:
Checksum: D800H
Save current BIOS as: old.bin

Message: Please Wait!
```

4. The utility saves the current BIOS file to the floppy disk, then returns to the BIOS flashing process.

```
AwardBIOS Flash Utility for ASUS V1.18
(C) Phoenix Technologies Ltd. All Rights Reserved

For C55XEMCP55PXE-StrikerE-00    DATE:10/30/2006
Flash Type - Unknown Flash

File Name to Program: 0115.bin
Now Backup System BIOS to
File!

Message: Please Wait!
```

4.2 BIOS setup program

This motherboard supports a programmable Low-Pin Count (LPC) chip that you can update using the provided utility described in section “4.1 Managing and updating your BIOS.”

Use the BIOS Setup program when you are installing a motherboard, reconfiguring your system, or prompted to “Run Setup.” This section explains how to configure your system using this utility.

Even if you are not prompted to use the Setup program, you can change the configuration of your computer in the future. For example, you can enable the security password feature or change the power management settings. This requires you to reconfigure your system using the BIOS Setup program so that the computer can recognize these changes and record them in the CMOS RAM of the LPC chip.

The LPC chip on the motherboard stores the Setup utility. When you start up the computer, the system provides you with the opportunity to run this program. Press during the Power-On Self-Test (POST) to enter the Setup utility; otherwise, POST continues with its test routines.

If you wish to enter Setup after POST, restart the system by pressing <Ctrl+Alt+Delete>, or by pressing the reset button on the system chassis. You can also restart by turning the system off and then back on. Do this last option only if the first two failed.

The Setup program is designed to make it as easy to use as possible. Being a menu-driven program, it lets you scroll through the various sub-menus and make your selections from the available options using the navigation keys.



-
- The default BIOS settings for this motherboard apply for most conditions to ensure optimum performance. If the system becomes unstable after changing any BIOS settings, load the default settings to ensure system compatibility and stability. Select the **Load Default Settings** item under the Exit Menu. See section “4.9 Exit Menu.”
 - The BIOS setup screens shown in this section are for reference purposes only, and may not exactly match what you see on your screen.
 - Visit the ASUS website (www.asus.com) to download the latest BIOS file for this motherboard.
-

4.2.1 BIOS menu screen

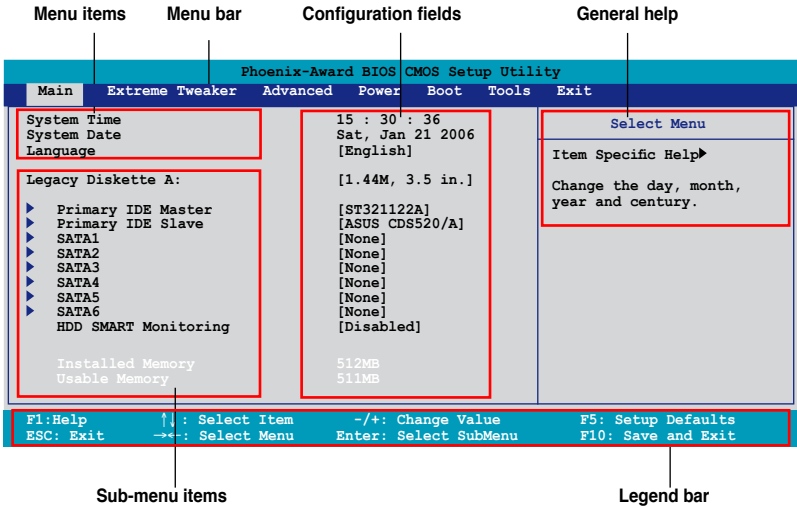

4.2.2 Menu bar

The menu bar on top of the screen has the following main items:

- Main** For changing the basic system configuration
- Extreme Tweaker** For changing the overclocking settings
- Advanced** For changing the advanced system settings
- Power** For changing the advanced power management (APM) configuration
- Boot** For changing the system boot configuration
- Tools** For configuring options for special functions
- Exit** For selecting the exit options and loading default settings

To select an item on the menu bar, press the right or left arrow key on the keyboard until the desired item is highlighted.



- The BIOS setup screens shown in this chapter are for reference purposes only, and may not exactly match what you see on your screen.
- Visit the ASUS website (www.asus.com) to download the latest BIOS information.

4.2.3 Legend bar

At the bottom of the Setup screen is a legend bar. The keys in the legend bar allow you to navigate through the various setup menus. The following table lists the keys found in the legend bar with their corresponding functions.

Navigation Key	Function
<F1>	Displays the General Help screen
<F5>	Loads setup default values
<Esc>	Exits the BIOS setup or returns to the main menu from a sub-menu
Left or Right arrow	Selects the menu item to the left or right
Up or Down arrow	Moves the highlight up or down between fields
Page Down or - (minus)	Scrolls backward through the values for the highlighted field
Page Up or + (plus)	Scrolls forward through the values for the highlighted field
<Enter>	Brings up a selection menu for the highlighted field
<F10>	Saves changes and exit

4.2.4 Menu items

The highlighted item on the menu bar displays the specific items for that menu. For example, selecting **Main** shows the Main menu items.

The other items (Advanced, Power, Boot, and Exit) on the menu bar have their respective menu items.

4.2.5 Sub-menu items

A solid triangle before each item on any menu screen means that the item has a sub-menu. To display the sub-menu, select the item and press <Enter>.

4.2.6 Configuration fields

These fields show the values for the menu items. If an item is user-configurable, you can change the value of the field opposite the item. You cannot select an item that is not user-configurable.

A configurable field is enclosed in brackets, and is highlighted when selected. To change the value of a field, select it then press <Enter> to display a list of options. Refer to “4.2.7 Pop-up window.”

4.2.7 Pop-up window

Select a menu item then press <Enter> to display a pop-up window with the configuration options for that item.

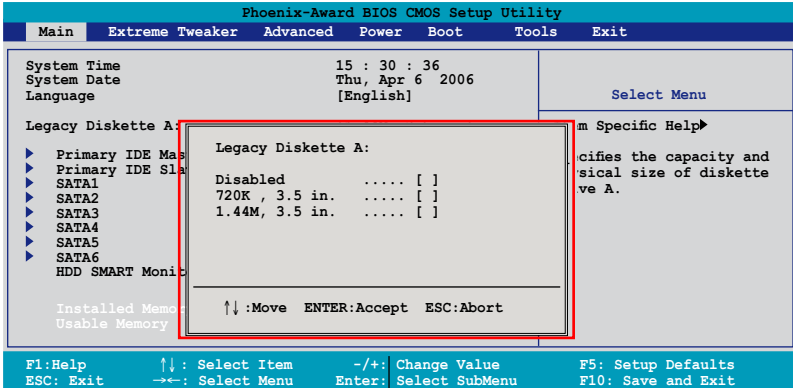

Pop-up menu

4.2.8 General help

At the top right corner of the menu screen is a brief description of the selected item.

4.3 Main menu

When you enter the BIOS Setup program, the Main menu screen appears, giving you an overview of the basic system information.



Refer to section “4.2.1 BIOS menu screen” for information on the menu screen items and how to navigate through them.

Phoenix-Award BIOS CMOS Setup Utility		
Main	Extreme Tweaker	Advanced Power Boot Tools Exit
System Time	15 : 30 : 36	Select Menu
System Date	Sat, Jan 21 2006	Item Specific Help▶ Change the day, month, year and century.
Language	[English]	
Legacy Diskette A:	[1.44M, 3.5 in.]	
▶ Primary IDE Master	[ST321122A]	
▶ Primary IDE Slave	[ASUS CDS520/A]	
▶ SATA1	[None]	
▶ SATA2	[None]	
▶ SATA3	[None]	
▶ SATA4	[None]	
▶ SATA5	[None]	
▶ SATA6	[None]	
HDD SMART Monitoring	[Disabled]	
Installed Memory	512MB	
Usable Memory	511MB	
F1: Help	↑↓: Select Item	-/+ : Change Value
ESC: Exit	→←: Select Menu	F5: Setup Defaults
		F10: Save and Exit

4.3.1 System Time [xx:xx:xx]

Allows you to set the system time.

4.3.2 System Date [Day xx/xx/xxxx]

Allows you to set the system date.

4.3.3 Language [English]

Allows you to choose the BIOS language version from the options. Configuration options: [English] [French] [Deutsch] [Chinese (Trad.)] [Chinese (Simp.)] [Japanese]

4.3.4 Legacy Diskette A [1.44M, 3.5 in.]

Sets the type of floppy drive installed.

Configuration options: [Disabled] [720K , 3.5 in.] [1.44M, 3.5 in.]

4.3.5 Primary IDE Master/Slave

While entering Setup, the BIOS automatically detects the presence of IDE devices. There is a separate sub-menu for each IDE device. Select a device item then press <Enter> to display the IDE device information.

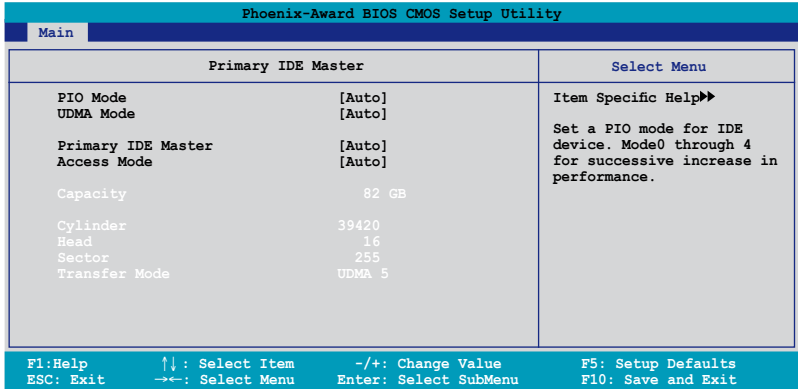

The BIOS automatically detects the values opposite the dimmed items (Capacity, Cylinder, Head, Sector and Transfer Mode). These values are not user-configurable. These items show N/A if no IDE device is installed in the system.

PIO Mode [Auto]

Sets the PIO mode for the IDE device.

Configuration options: [Auto] [Mode 0] [Mode 1] [Mode 2] [Mode 3] [Mode 4]

UDMA Mode [Auto]

Disables or sets the UDMA mode. Configuration options: [Disable] [Auto]

Primary IDE Master/Slave [Auto]

Select [Auto] to automatically detect an IDE hard disk drive. If automatic detection is successful, the BIOS automatically fills in the correct values for the remaining fields on this sub-menu. If the hard disk was already formatted on a previous system, the setup BIOS may detect incorrect parameters. Select [Manual] to manually enter the IDE hard disk drive parameters. If no drive is installed select [None]. Configuration options: [None] [Auto] [Manual]

Access Mode [Auto]

The default [Auto] allows automatic detection of an IDE hard disk drive. Select [CHS] for this item if you set the IDE Primary Master/Slave to [Manual]. Configuration options: [CHS] [LBA] [Large] [Auto]



Before attempting to configure a hard disk drive, make sure you have the correct configuration information supplied by the drive manufacturer. Incorrect settings may cause the system to fail to recognize the installed hard disk.

Capacity

Displays the auto-detected hard disk capacity. This item is not configurable.

Cylinder

Shows the number of the hard disk cylinders. This item is not configurable.

Head

Shows the number of the hard disk read/write heads. This item is not configurable.

Sector

Shows the number of sectors per track. This item is not configurable.

Transfer Mode

Shows the Transfer mode. This item is not configurable.



After entering the IDE hard disk drive information into BIOS, use a disk utility, such as FDISK, to partition and format new IDE hard disk drives. This is necessary so that you can write or read data from the hard disk. Make sure to set the partition of the Primary IDE hard disk drives to active.

4.3.6 SATA1/2/3/4/5/6

While entering Setup, the BIOS automatically detects the presence of Serial ATA devices. There is a separate sub-menu for each SATA device. Select a device item then press <Enter> to display the SATA device information.

Phoenix-Award BIOS CMOS Setup Utility		
Main		
SATA1		Select Menu
Extended IDE Drive Access Mode	[Auto] [Auto]	Item Specific Help▶▶ Selects the type of fixed disk connected to the system.
Capacity	0 MB	
Cylinder	0	
Head	0	
Landing Zone	0	
Sector	0	
F1: Help ↓↑: Select Item -/+ : Change Value F5: Setup Defaults ESC: Exit →←: Select Menu Enter: Select SubMenu F10: Save and Exit		

The BIOS automatically detects the values opposite the dimmed items (Capacity, Cylinder, Head, Landing Zone and Sector). These values are not user-configurable. These items show 0 if no SATA device is installed in the system.

Extended IDE Drive [Auto]

Selects the type of fixed disk connected to the system.

Configuration options: [None] [Auto]

Access Mode [Auto]

Sets the sector addressing mode. Configuration options: [Large] [Auto]



Before attempting to configure a hard disk drive, make sure you have the correct configuration information supplied by the drive manufacturer. Incorrect settings may cause the system to fail to recognize the installed hard disk.

Capacity

Displays the auto-detected hard disk capacity. This item is not configurable.

Cylinder

Shows the number of the hard disk cylinders. This item is not configurable.

Head

Shows the number of the hard disk read/write heads. This item is not configurable.

Landing Zone

Shows the number of landing zone per track. This item is not configurable.

Sector

Shows the number of sectors per track. This item is not configurable.



After entering the IDE hard disk drive information into BIOS, use a disk utility, such as FDISK, to partition and format new IDE hard disk drives. This is necessary so that you can write or read data from the hard disk. Make sure to set the partition of the Primary IDE hard disk drives to active.

4.3.7 HDD SMART Monitoring [Disabled]

Allows you to enable or disable the HDD Self-Monitoring Analysis and Reporting Technology (SMART) feature. Configuration options: [Disabled] [Enabled]

4.3.8 Installed Memory [xxx MB]

Shows the size of installed memory.

4.3.9 Usable Memory [XXX MB]

Shows the size of usable memory.

4.4 Extreme Tweaker menu

The Extreme menu items allow you to configure overclocking-related items.



Take caution when changing the settings of the Extreme menu items. Incorrect field values can cause the system to malfunction.

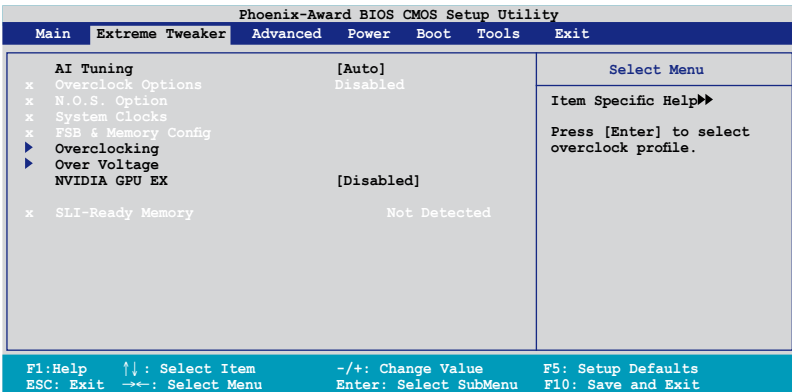

4.4.1 AI Tuning [Auto]

Allows selection of CPU overclocking options to achieve desired CPU internal frequency. Select either one of the preset overclocking configuration options:

Manual Allows you to individually set overclocking parameters.

Auto Loads the optimal settings for the system.

Standard Loads the standard settings for the system.

AI Overclock Loads overclocking profiles with optimal parameters for stability when overclocking.

AI N.O.S. The ASUS Non-delay Overclocking System feature intelligently determines the system load and automatically boosts the performance for the most demanding tasks.



The following item becomes user-configurable when you set **AI Tuning** to [AI Overclock]

Overclock Options [Disabled]

Allows you to set the overclocking options.

Configuration options: [Disabled] [Overclock 5%] [Overclock 10%] [Overclock 15%] [Overclock 20%] [FSB 960/800] [FSB 1280/800] [FSB 1000/667] [FSB 1333/667] [FSB 1200/800]



The following items become user-configurable when you set **AI Tuning** to [Manual].

System Clocks

This sub-menu allows you to adjust the system frequency-related items. Select an item, then press <Enter> to edit.

Phoenix-Award BIOS CMOS Setup Utility	
Extreme Tweaker	
System Clocks	Select Menu
PCIEX16_1 Frequency (MHz) [100]	Item Specific Help▶▶▶
PCIEX16_2 Frequency (MHz) [100]	Set C55 PCIe Overclock
PCIEX16_3 Frequency (MHz) [100]	
SPP <-> MCP Ref Clock, MHz [Auto]	

PCIEX16_1 Frequency (MHz) [100]

Allows you to set the PCIEX16_1 overclocking frequency.
Configuration options: [100 MHz]~[200 MHz]

PCIEX16_2 Frequency (MHz) [100]

Allows you to set the PCIEX16_2 overclocking frequency.
Configuration options: [100 MHz]~[200 MHz]

PCIEX16_3 Frequency (MHz) [100]

Allows you to set the PCIEX16_3 overclocking frequency.
Configuration options: [100 MHz]~[200 MHz]

SPP <-> MCP Ref Clock, MHz [Auto]

Configuration options: [Auto] [200.0 MHz] [200.5 MHz] [201.0 MHz] [201.5 MHz]...[500.0 MHz]



FSB & Memory Config

This sub-menu allows you to adjust the system frequency-related items. Select an item, then press <Enter> to edit.

Phoenix-Award BIOS CMOS Setup Utility		
Extreme Tweaker		Select Menu
FSB & Memory Config		Select Menu
FSB - Memory Clock Mode	[Linked]	Item Specific Help▶▶▶
FSB - Memory Ratio	[Auto]	System clock mode
FSB (QDR), MHz	[800]	
Actual FSB (QDR), MHz	800.0	
x MEM (DDR), MHz	Linked	[Optimal]
Actual MEM (DDR), MHz	667	Set FSB and memory speed automatically.
ECC Control	[Disabled]	[Linked]
ECC Uncorrectable	[Disabled]	Enter FSB Speed manually.
ECC Correctable	[Disabled]	Memory Speed changes proportionally.

F1: Help ↑↓: Select Item -/+ : Change Value F5: Setup Defaults
 ESC: Exit →←: Select Menu Enter: Select SubMenu F10: Save and Exit

FSB - Memory Clock Mode [Auto]

Allows you to set the system clock mode.

Configuration options: [Auto] [Linked] [Unlinked]



The following items become user-configurable when you set the **FSB-Memory Clock Mode** item to [Linked].

FSB - Memory Ratio [Auto]

Configuration options: [Auto] [1:1] [5:4] [3:2] [Sync Mode]

FSB (QDR), MHz [800]

Configuration options: [533 MHz]~[2600 MHz]



The following item becomes user-configurable when you set the **FSB-Memory Clock Mode** item to [Unlinked].

FSB (QDR), MHz [800]

Configuration options: [533]~[3000]

MEM (DDR), MHz [667]

Configuration options: [400]~[1400]

ECC Control [Disabled]

Configuration options: [Disabled] [Auto]

ECC Uncorrectable [Disabled]

Configuration options: [Disabled] [No Notify] [MCERR] [NMI] [SCI] [SMI]

ECC Correctable [Disabled]

Configuration options: [Disabled] [No Notify] [MCERR] [NMI] [SCI] [SMI]

4.4.2 Overclocking

This sub-menu allows you to adjust the system frequency-related items. Select an item, then press <Enter> to edit.

Phoenix-Award BIOS CMOS Setup Utility			
Extreme Tweaker			
Overclocking			Select Menu
CPU Type	Genuine Intel (R) CPU		Item Specific Help▶▶▶
CPU Speed	2.80GHz		
Cache RAM	1024K x2		
CPU Multiplier	[17]		
▶	Memory Timing Setting		
▶	Spread Spectrum Control		
	Intel SpeedStep	[Disabled]	
	CPU Internal Thermal Control	[Auto]	
X	TM2 Bus Ratio	12.4	
X	TM2 Bus VID	1.2000V	
	Limit CPUID MaxVal	[Disabled]	
	EnhancedC1 (C1E)	[Disabled]	
	Execute Disable Bit	[Enabled]	
	Enhanced Intel SpeedStep (tm) Tech.	[Disabled]	
	Hyper-Threading Technology	[Enabled]	
	DDT Frequency	[5x]	
F1: Help	↑↓: Select Item	-/+ : Change Value	
ESC: Exit	→←: Select Menu	Enter: Select Sub-menu	F10: Save and Exit

CPU Multiplier [17]

Configuration options: [6]~[50]

Memory Timing Setting

Phoenix-Award BIOS CMOS Setup Utility				
Extreme Tweaker				
Memory Timing Setting			Select Menu	
tCL (CAS Latency)	[Auto]		Item Specific Help▶▶▶	
tRCD	[Auto]			
tRAS	[Auto]			
Command Per Clock (CMD)	[Auto]			
** Advanced Memory Settings **				
tRRD	[Auto]			
tRC	[Auto]			
tWR	[Auto]			
tWTR	[Auto]			
tREF	[Auto]			
Async Latency	[Auto]			

tCL (CAS Latency) [Auto]

Configuration options: [Auto] [1] [2] [3] [4] [5] [6]

tRCD [Auto]

Configuration options: [Auto] [1] [2] [3] [4] [5] [6] [7]

tRP [Auto]

Configuration options: [Auto] [1] [2] [3] [4] [5] [6] [7]

tRAS [Auto]

Configuration options: [Auto] [1] [2] [3] [4] [5] [6] [7]...[31]

Command Per Clock (CMD) [Auto]

Configuration options: [Auto] [1 clock] [2 clock]

tRRD [Auto]

Configuration options: [Auto] [1] [2] [3] [4] [5] [6] [7]...[15]

tRC [Auto]

Configuration options: [Auto] [1] [2] [3] [4] [5] [6] [7]...[31]

tWR [Auto]

Configuration options: [Auto] [1] [2] [3] [4] [5] [6] [7]

tWTR [Auto]

Configuration options: [Auto] [1] [2] [3] [4] [5] [6] [7]...[15]

tREF [Auto]

Configuration options: [Auto] [1] [2]

Async Latency [Auto]

Configuration options: [Auto] [1.00nS] [1.25nS] [1.50nS] [1.75nS] [2.00nS]
[2.25nS] [2.50nS]

Spread Spectrum Control

Phoenix-Award BIOS CMOS Setup Utility		
Extreme Tweaker		
Spread Spectrum Control		Select Menu
CPU Spread Spectrum	[Disabled]	Item Specific Help▶▶▶
PCI-E Spread Spectrum	[Down Spread]	
MCP PCI-E Spread Spectrum	[Down Spread]	
SATA Spread Spectrum	[Disabled]	
LDT Spread Spectrum	[Disabled]	

CPU Spread Spectrum [Disabled]

Configuration options: [Disabled] [Center Spread] [UP Spread]

PCI-E Spread Spectrum [Down Spread]

Configuration options: [Disabled] [Down Spread]

MCP PCI-E Spread Spectrum [Down Spread]

Configuration options: [Disabled] [Down Spread]

SATA Spread Spectrum [Disabled]

Configuration options: [Disabled] [Enabled]

LDT Spread Spectrum [Disabled]

Configuration options: [Disabled] [Center] [Down]

Intel SpeedStep [Disabled]

This item is user-configurable only when you set [AI Tuning] to [Standard], [Auto], or [AI N.O.S.]. Configuration options: [Auto] [Disabled]

CPU Internal Thermal Control [Auto]

Configuration options: [Auto] [Disabled]

Limit CPUID MaxVal [Disabled]

Configuration options: [Disabled] [Enabled]

Enhanced C1 (C1E) [Disabled]

Configuration options: [Disabled] [Enabled]

Execute Disable Bit [Enabled]

Configuration options: [Disabled] [Enabled]

Enhanced Intel SpeedStep(tm) Tech. [Disabled]

Configuration options: [Disabled] [Enabled]

Hyper-Threading Technology [Enabled]

Configuration options: [Disabled] [Enabled]

LDT Frequency [5x]

Configuration options: [1x] [2x] [3x] [4x] [5x]

4.4.3 Over Voltage

This sub-menu allows you to adjust the system voltage-related items. Select an item, then press <Enter> to edit.

Phoenix-Award BIOS CMOS Setup Utility	
Extreme Tweaker	
Over Voltage	Select Menu
VCore Voltage [Auto]	Item Specific Help▶▶▶
Memory Voltage [Auto]	
1.2V HT Voltage [Auto]	
NB Core Voltage [Auto]	Set CPU VID to desired voltage, but it will cause other CPU power management feature such as C1E, EIST, and TM2) fail to control CPU VID. Select [Auto] to let CPU VID keep original value.
SB Core Voltage [Auto]	
CPU VTT Voltage [Auto]	
DDR2 Controller Ref Voltage [Auto]	
DDR2 Channel A Ref Voltage [Auto]	
DDR2 Channel B Ref Voltage [Auto]	

VCore Voltage [Auto]

Configuration options: [Auto] [1.90000V] [1.89375V] [1.88750V] [1.88125V] [1.87500V]...[0.83750V] [0.83125V]

Memory Voltage [Auto]

Configuration options: [Auto] [1.850V] [1.875V] [1.900V]...[3.400V] [3.425V]

1.2V HT Voltage [Auto]

Configuration options: [Auto] [1.20V] [1.25V] [1.30V]...[1.90V] [1.95V]

NB Core Voltage [Auto]

Configuration options: [Auto] [1.20V] [1.25V] [1.30V]...[2.70V] [2.75V]

SB Core Voltage [Auto]

Configuration options: [Auto] [1.50V] [1.55V] [1.60V] [1.65V] [1.70V] [1.75V] [1.80V] [1.85V]

CPU VTT Voltage [Auto]

Configuration options: [Auto] [1.20V] [1.25V] [1.30V] [1.35V]...[1.50V] [1.55V]

DDRII Controller Ref Voltage [Auto]

Configuration options: [Auto] [DDR2_Vol/2] [DDR2_Vol/2-30mv] [DDR2_Vol/2-20mv] [DDR2_Vol/2-10mv] [DDR2_Vol/2+10mv] [DDR2_Vol/2+20mv] [DDR2_Vol/2+30mv]

DDR2 Channel A Ref Voltage / DDR2 Channel B Ref Voltage [Auto]

Allows you to set the DDR2 Controller/ChannelA/B Ref voltage.

Configuration options: Configuration options: [Auto] [DDR2_Vol/2] [DDR2_Vol/2-30mv] [DDR2_Vol/2-20mv] [DDR2_Vol/2-10mv] [DDR2_Vol/2+10mv] [DDR2_Vol/2+20mv] [DDR2_Vol/2+30mv]

4.4.4 **NVIDIA GPU Ex [Disabled]**

Enables or disables with the optimized NVIDIA Ex graphics driver.

Configuration options: [Auto] [Disabled]

4.4.5 **SLI-Ready Memory [Disabled]**

Allows you to select the SPD profile for SLI-Ready memory modules. The configuration options may vary depending on the type of module you installed.

Configuration options: [Disabled] [Optimal] [High Performance] [High Frequency]



The following item becomes user-configurable when SLI-Ready Memory is set to Enabled.

4.4.6 **SLI-Ready Memory CPUOC [CPUOC 0%]**

Configuration options: [CPUOC 0%] [CPUOC 1%]~[CPUOC 14%] [CPUOC MAX]

4.5 Advanced menu

The Advanced menu items allow you to change the settings for system devices.



Take caution when changing the settings of the Advanced menu items. Incorrect field values can cause the system to malfunction.

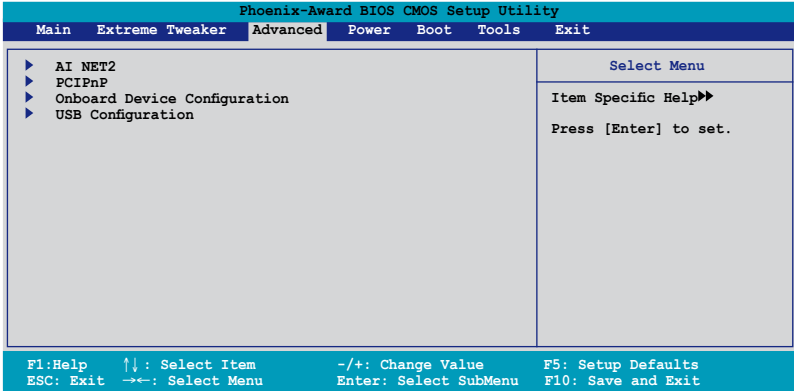

4.5.1 AI NET2

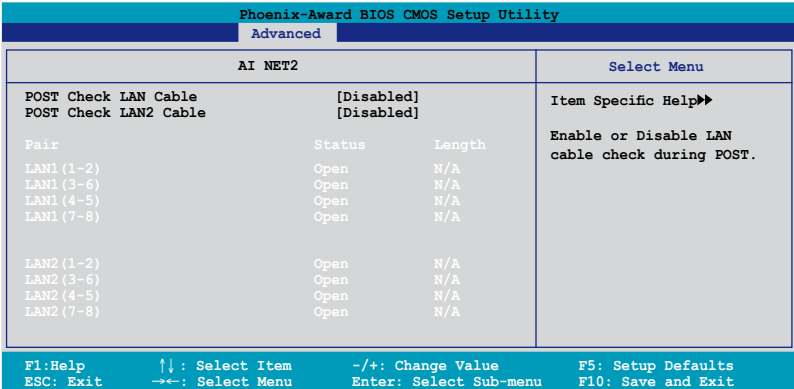

POST Check LAN Cable [Disabled] POST Check LAN2 Cable [Disabled]

Enables or disables checking of the LAN/LAN2 cable during the Power-On Self-Test (POST). Configuration options: [Disabled] [Enabled]

4.5.2 PCIPnP

Phoenix-Award BIOS CMOS Setup Utility	
Advanced	
PCIPnP	Select Menu
Plug & Play O/S [No] Primary Display Adapter [PCI]	Item Specific Help▶▶ Select Yes if you are using a Plug and Play capable operating system. Select No if you need the BIOS to configure non-boot devices.

Plug & Play O/S [No]

When set to [No], the BIOS configures all the devices in the system. When set to [Yes] and if you install a Plug and Play operating system, the operating system configures the Plug and Play devices not required for boot. Configuration options: [No] [Yes]

Primary Display Adapter [PCI]

Allows you to select the graphics controller to use as the primary boot device. Configuration options: [PCI] [PCI-E]

4.5.3 Onboard Device Configuration

Phoenix-Award BIOS CMOS Setup Utility	
Advanced	
Onboard Device Configuration	Select Menu
<ul style="list-style-type: none"> ▶ IDE Function Setup ▶ Serial-ATA Configuration HD Audio [Auto] Front Panel Support Type [AC97] Onboard 1st nVidia LAN [Enabled] Onboard 2nd nVidia LAN [Enabled] Onboard LAN Boot ROM [Disabled] Silicon SATAII Controller [SATA Mode] Onboard 1394 [Enabled] LCD Poster Backlight [Disabled] LCD Poster Mode [Current Time] x LCD Poster String Internal Connector LED [by Switch] 	Item Specific Help▶▶
F1: Help ↑↓ : Select Item -/+ : Change Value F5: Setup Defaults ESC: Exit →← : Select Menu Enter: Select SubMenu F10: Save and Exit	

IDE Function Setup

This sub-menu contains IDE function-related items. Select an item then press <Enter> to edit.

Phoenix-Award BIOS CMOS Setup Utility	
Advanced	
IDE Function Setup	Select Menu
OnChip IDE Channel0 [Enabled] IDE DMA transfer access [Enabled] IDE Prefetch Mode [Enabled]	Item Specific Help▶▶▶

OnChip IDE Channel0 [Enabled]

Allows you to enable or disable the onchip IDE channel 0 controller .
 Configuration options: [Disabled] [Enabled]

IDE DMA transfer access [Enabled]

Allows you to enable or disable the IDE DMA transfer access.
 Configuration options: [Disabled] [Enabled]

IDE Prefetch Mode [Enabled]

Allows you to enable or disable the IDE PIO read prefetch mode.
 Configuration options: [Disabled] [Enabled]

Serial-ATA Configuration

This sub-menu allows you to change Serial ATA settings. Select an item then press <Enter> to edit.

Phoenix-Award BIOS CMOS Setup Utility			
Advanced			
Serial-ATA Configuration			Select Menu
	Serial-ATA Controller	[Enabled]	Item Specific Help▶▶▶
	RAID Enabled	[Disabled]	
x	SATA1	RAID Disabled	
x	SATA2	RAID Disabled	
x	SATA3	RAID Disabled	
x	SATA4	RAID Disabled	
x	SATA5	RAID Disabled	
x	SATA6	RAID Disabled	

Serial-ATA Controller [Enabled]

Allows you to enable or disable the onboard Serial ATA controller.

Configuration options: [Disabled] [Enabled]

RAID Enabled [Disabled]

Enables or disables the onboard RAID controller. When set to [Enabled], the succeeding items become user-configurable. Configuration options:

[Disabled] [Enabled]

SATA1/2/3/4/5/6 [Disabled]

Enables or disables the RAID function of the first to sixth SATA master drive.

Configuration options: [Disabled] [Enabled]

HD Audio [Auto]

Allows you to disable or set the High-Definition audio function.

Configuration options: [Auto] [Disabled]

Front Panel Support Type [HD Audio]

Allows you to set the front panel audio connector (AAFP) mode to legacy AC'97 or high-definition audio depending on the audio standard that the front panel audio module supports. Configuration options: [AC97] [HD Audio]

Onboard 1st/2nd Nvidia LAN [Enabled]

Enables or disables the onboard NVIDIA® LAN controller.

Configuration options: [Disabled] [Enabled]

OnBoard LAN Boot ROM [Disabled]

Allows you to enable or disable the onboard LAN boot ROM.

Configuration options: [Enabled] [Disabled]

Silicon SATAII Controller

Allows you to disable or set the function of the extended SATA II controller.

Configuration options: [Disabled] [SATA Mode] [RAID Mode]

Onboard 1394 [Enabled]

Allows you to disable or enable the onboard 1394 device support.

Configuration options: [Disabled] [Enabled]

LCD Poster Backlight [Disabled]

Allows you to enable or disable the LCD poster backlight.

Configuration options: [Disabled] [Enabled]

LCD Poster Mode [Current Time]

Allows you to select the LCD poster mode.

Configuration options: [Current Time] [User String]



The following item becomes configurable when the "LCD Poster Mode" item is set to [User String].

LCD Poster String

Allows you to enter a string on the LCD poster.

Internal Connector LED [by Switch]

Configuration options: [Always On] [by Switch]

USB Configuration

The items in this menu allows you to change the USB-related features. Select an item then press <Enter> to display the configuration options.

Phoenix-Award BIOS CMOS Setup Utility	
Advanced	
USB Configuration	Select Menu
USB Controller [Enabled]	Item Specific Help▶▶▶ Enable or disable the USB 1.1 and 2.0 Controller.
USB2.0 Controller [Enabled]	
USB Legacy support [Enabled]	

USB Controller [Enabled]

Allows you to enable or disable the onchip USB controller.

Configuration options: [Disabled] [Enabled]

USB 2.0 Controller [Enabled]

Allows you to enable or disable the USB 2.0 controller.

Configuration options: [Disabled] [Enabled]

USB Legacy Support [Enabled]

Allows you to enable or disable support for USB devices on legacy operating systems (OS). Configuration options: [Disabled] [Enabled]

4.6 Power menu

The Power menu items allow you to change the settings for the Advanced Configuration and Power Interface (ACPI) and the Advanced Power Management (APM). Select an item then press <Enter> to display the configuration options.

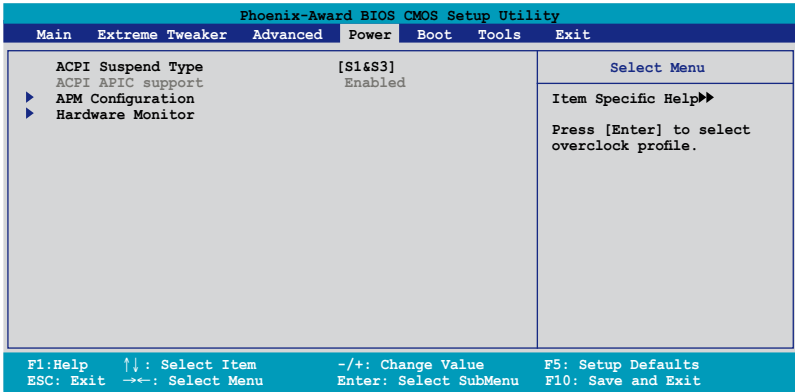

4.6.1 ACPI Suspend Type [S1&S3]

Allows you to select the Advanced Configuration and Power Interface (ACPI) state to be used for system suspend. Configuration options: [S1 (POS)] [S3(STR)] [S1&S3]

4.6.2 ACPI APIC Support [Enabled]

Allows you to enable or disable the Advanced Configuration and Power Interface (ACPI) support in the Application-Specific Integrated Circuit (ASIC). When set to Enabled, the ACPI APIC table pointer is included in the RSDT pointer list. Configuration options: [Disabled] [Enabled]

4.6.3 APM Configuration

Phoenix-Award BIOS CMOS Setup Utility			
Power			
APM Configuration		Select Menu	
Restore on AC Power Loss	[Power-Off]	Item Specific Help▶▶ Press [Enter] to select whether or not to restart the system after AC power loss	
PWR Button < 4 secs	[Instant-Off]		
Power Up On PCI/PCIE Devices	[Disabled]		
Power On By External Modems	[Disabled]		
USB Resume from S5	[Disabled]		
Power On by RTC Alarm	[Disabled]		
* Date (of Month) Alarm	0		
* Alarm Time (hh:mm)	0 : 0 : 0		
HPET Support	[Enabled]		
Power Up By PS/2 Mouse	[Disabled]		
Power Up By PS/2 Keyboard	[Disabled]		
F1: Help	↑↓ : Select Item	-/+ : Change Value	F5: Setup Defaults
ESC: Exit	→← : Select Menu	Enter: Select SubMenu	F10: Save and Exit

Restore on AC Power Loss [Power-Off]

Allows you to enable or disable the Restore on AC Power Loss function.
 Configuration options: [Power-Off] [Power-On] [Last State]

PWR Button < 4 secs [Instant-Off]

Allows you to set the event after the power button is pressed for more than 4 seconds. Configuration options: [Suspend] [Instant-Off]

Power Up On PCI/PCIE Devices [Disabled]

Allows you to enable or disable the PME to wake up from S5 by PCI devices & NV Onboard LAN. Configuration options: [Disabled] [Enabled]

Power On By External Modem [Disabled]

This allows either settings of [Enabled] or [Disabled] for powering up the computer when the external modem receives a call while the computer is in Soft-off mode.
 Configuration options: [Disabled] [Enabled]



The computer cannot receive or transmit data until the computer and applications are fully running. Thus, connection cannot be made on the first try. Turning an external modem off and then back on while the computer is off causes an initialization string that turns the system power on.

USB Resume from S5 [Disabled]

Allows you to enable or disable the support of USB keyboard or mouse resumption from S5. Configuration options: [Disabled] [Enabled]

Restore on AC Power Loss [Power-Off]

Allows you to enable or disable the Restore on AC Power Loss function.

Configuration options: [Power-Off] [Power-On]

PWR Button < 4 secs [Instant-Off]

Allows you to set the event after the power button is pressed for more than 4 seconds. Configuration options: [Suspend] [Instant-Off]

Power Up On PCI/PCIE Devices [Disabled]

Allows you to enable or disable the PME to wake up from S5 by PCI devices & NV Onboard LAN. Configuration options: [Disabled] [Enabled]

Alarm Time (hh:mm) [X: X: X]

To set the time of alarm:

1. Highlight this item and press <Enter> to display a pop-up menu for the hour field.
2. Key-in a value (Min=0, Max=23), then press <Enter>.
3. Press <TAB> to move to the minutes field then press <Enter>.
4. Key-in a minute value (Min=0, Max=59), then press <Enter>.

HPET Support [Enabled]

Configuration options: [Disabled] [Enabled]

Power Up By PS/2 Mouse [Disabled]

When set to [Enabled], this parameter allows you to use the PS/2 mouse to turn on the system. This feature requires an ATX power supply that provides at least 1A on the +5VSB lead. Configuration options: [Disabled] [Enabled]

Power Up By PS/2 Keyboard [Disabled]

Allows you to disable the Power On by PS/2 keyboard function or set specific keys on the PS/2 keyboard to turn on the system. This feature requires an ATX power supply that provides at least 1A on the +5VSB lead. Configuration options: [Disabled] [Space Bar] [Ctrl-ESC] [Power Key]

4.6.4 Hardware Monitor

The items in this sub-menu displays the hardware monitor values automatically detected by the BIOS. It also allows you to change CPU Q-Fan feature-related parameters. Select an item then press <Enter> to display the configuration options.

Phoenix-Award BIOS CMOS Setup Utility	
Power	
Hardware Monitor	Select Menu
<ul style="list-style-type: none"> ▶ Voltage Monitor ▶ Temperature Monitor ▶ Fan Speed Monitor ▶ Fan Speed Control CPU Fan Speed warning [600 RPM] 	Item Specific Help▶▶ Press [Enter] to go to the sub-menu.
F1: Help ↑↓ : Select Item -/+ : Change Value F5: Setup Defaults ESC: Exit →← : Select Menu Enter: Select SubMenu F10: Save and Exit	

Phoenix-Award BIOS CMOS Setup Utility	
Power	
Voltage Monitor	Select Menu
Vcore Voltage [1.32V] Memory Voltage [1.84V] 1.2V HT Voltage [1.23V] NB Voltage [1.20V] SB Voltage [1.50V] CPU VTT Voltage [1.34V] DDR2 Termination Voltage [0.92V] 3.3V Voltage [2.94V] 5V Voltage [4.81V] 12V Voltage [11.07V]	Item Specific Help▶▶ Press [Enter] to set.
F1: Help ↑↓ : Select Item -/+ : Change Value F5: Setup Defaults ESC: Exit →← : Select Menu Enter: Select SubMenu F10: Save and Exit	

Vcore / 3.3V / 5V / 12V Voltage
+1.2V HT / +1.5V Voltage
VTT CPU / DDR2 Termination / DDR2 Voltage
+1.4V / DDR2 Voltage

The onboard hardware monitor automatically detects the voltage output through the onboard voltage regulators.

Temperature Monitor

Phoenix-Award BIOS CMOS Setup Utility		
Power		
Temperature Monitor		Select Menu
CPU Temperature	57°C	Item Specific Help▶▶
M/B Temperature	37°C	
OPT1 Temperature	0°C	
OPT2 Temperature	0°C	
OPT3 Temperature	0°C	

CPU, M/B, OPT1/2/3 Temperature

The onboard hardware monitor automatically detects and displays the motherboard, CPU, and OPT1/2/3 temperatures. These items are not user-configurable.

Fan Speed Monitor

Phoenix-Award BIOS CMOS Setup Utility		
Power		
Fan Speed Monitor		Select Menu
CPU Fan Speed	2960 RPM	Item Specific Help▶▶
CHA FAN1 Speed	0 RPM	
OPT1 FAN Speed	0 RPM	
OPT2 FAN Speed	0 RPM	
OPT3 FAN Speed	0 RPM	
OPT4 FAN Speed	0 RPM	
OPT5 FAN Speed	0 RPM	
PWR FAN Speed	0 RPM	

CPU FAN / CHA FAN1 Speed

OPT1/2/3/4/5 FAN Speed

PWR FAN Speed

The onboard hardware monitor automatically detects and displays the CPU, Chassis, and OPT1/2/3/4/5 fan speed in rotations per minute (RPM). If any of the fans is not connected to the motherboard, the field shows 0. These items are not user-configurable.

Fan Speed Control

Phoenix-Award BIOS CMOS Setup Utility		
Power		
Fan Speed Control		Select Menu
	CPU Fan Control	[Duty Cycle Mode]
	CPU Fan Duty Cycle	[100%]
	CHA Fan Control	[Duty Cycle Mode]
	CHA Fan Duty Cycle	[100%]
x	CHA Fan Q-Fan Sense	CPU Temperature
	OPT Fan1 Control	[Duty Cycle Mode]
	OPT Fan1 Duty Cycle	[100%]
x	OPT Fan1 Target Temperature	40°C/104°F
	OPT Fan2 Control	[Duty Cycle Mode]
	OPT Fan2 Duty Cycle	[100%]
x	OPT Fan2 Target Temperature	40°C/104°F
	OPT Fan3 Control	[Duty Cycle Mode]
	OPT Fan3 Duty Cycle	[100%]
x	OPT Fan3 Target Temperature	40°C/104°F
	OPT Fan4 Duty Cycle	[100%]
	OPT Fan5 Duty Cycle	[100%]
	PWR FAN Duty Cycle	[100%]
		Item Specific Help▶▶
		Press [Enter] to enable or disable.

CPU / CHA / OPT Fan1, 2, 3, Fan Control

[Duty Cycle Mode]

Allows you to select the fan control mode.

Configuration options: [Duty Cycle Mode] [Q-FAN Mode]

CPU / CHA / PWR / OPT Fan1, 2, 3, 4, 5 Fan Duty Cycle [100%]

Allows you to set the fan duty cycle. When the Fan Control item is set to Q-FAN Mode, this item is not user-configurable.

Configuration options: [60%] [70%] [80%] [90%] [100%]

CHA Fan Q-Fan Sense [CPU Temperature]

Allows the Q-Fan to sense CPU/MB temperature and to adjust the fan speed.

When the previous items are set to Q-FAN Mode, these items become user-configurable. Configuration options: [CPU Temperature] [MB Temperature]

OPT Fan1/2/3 Target Temperature [40°C/104°F]

Allows the Q-Fan to sense the temperature of fans connected to OPT Fan1/2/3 and to adjust the fan speed. When the OPT Fan1/2/3 Control items are set to Q-FAN Mode, these items become user-configurable.

Configuration options: [10°C/50°F] [15°C/59°F] [20°C/68°F] [25°C/77°F] [30°C/86°F] [35°C/95°F] [40°C/104°F] [45°C/113°F] [50°C/122°F] [55°C/131°F] [60°C/140°F] [65°C/149°F] [70°C/158°F] [75°C/167°F] [80°C/176°F] [85°C/185°F]



The thermo sensor cables need to be connected to the optional fans first for this function.

CPU Fan Speed warning [600 RPM]

Allows you to set the CPU fan warning speed function, which gives off a warning when the CPU fan speed is too low. If you set this item to [Disabled], the system will not warn you even if no fan is installed or if the fan is not functioning properly. Configuration options: [Disabled] [600 RPM] [1200 RPM] [1600 RPM]

4.7 Boot menu

The Boot menu items allow you to change the system boot options. Select an item then press <Enter> to display the sub-menu.

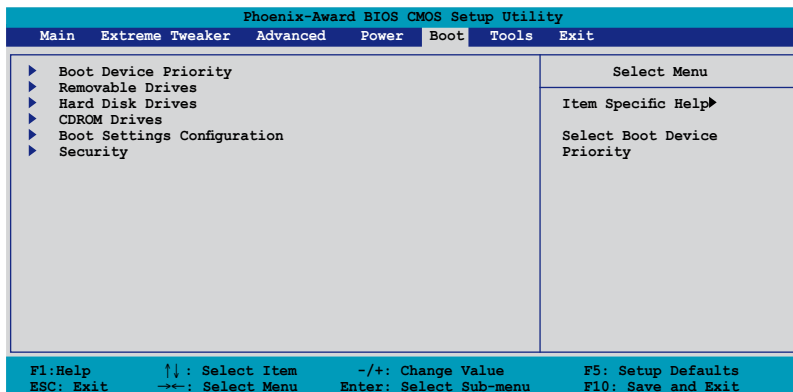

4.7.1 Boot Device Priority

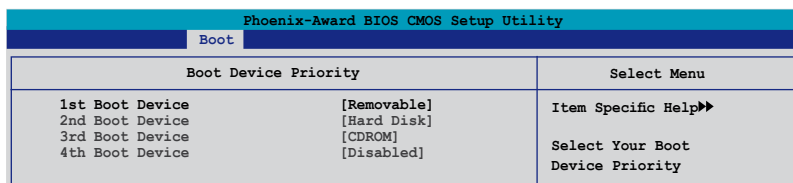

1st ~ 4th Boot Device [Removable]

These items specify the boot device priority sequence from the available devices. The number of device items that appears on the screen depends on the number of devices installed in the system.

Configuration options: [Removable] [Hard Disk] [CDROM] [Disabled]

4.7.2 Removable Drives

Phoenix-Award BIOS CMOS Setup Utility	
Boot	
Removable Drives	Select Menu
1. Floppy Disks	Item Specific Help▶▶

1. Floppy Disks

Allows you to assign a removable drive attached to the system.

4.7.3 Hard Disk Drives

Phoenix-Award BIOS CMOS Setup Utility	
Boot	
Hard Disk Drives	Select Menu
1. 1st Master: XXXXXXXXX	Item Specific Help▶▶

1. 1st Master: XXXXXXXXX

Allows you to assign hard disk drives attached to the system.

4.7.4 CDROM Drives

Phoenix-Award BIOS CMOS Setup Utility	
Boot	
Hard Disk Drives	Select Menu
1. 1st Slave: XXXXXXXXX	Item Specific Help▶▶

1. 1st Slave: XXXXXXXXX

Allows you to assign optical drives attached to the system.

4.7.5 Boot Settings Configuration

Phoenix-Award BIOS CMOS Setup Utility		
Boot		
Boot Settings Configuration		Select Menu
Case Open Warning	[Enabled]	Item Specific Help▶▶ Press [Enter] to enable or disable.
Quick Boot	[Enabled]	
Boot Up Floppy Seek	[Disabled]	
Bootup Num-Lock	[On]	
Typematic Rate Setting	[Disabled]	
x Typematic Rate (Chars/Sec)	6	
x Typematic Delay (Msec)	250	
OS Select For DRAM > 64MB	[Non-OS2]	
Full Screen LOGO	[Enabled]	
Halt On	[All Errors]	

F1: Help ↑↓: Select Item -/+ : Change Value F5: Setup Defaults
ESC: Exit →←: Select Menu Enter: Select Sub-menu F10: Save and Exit

Case Open Warning [Enabled]

Enables or disables the chassis open status feature. Setting to Enabled, clears the chassis open status. Refer to section “2.8.2 Internal connectors” for setting details. Configuration options: [Disabled] [Enabled]

Quick Boot [Enabled]

Allows you to enable or disable the system quick boot feature. When Enabled, the system skips certain tests while booting. Configuration options: [Disabled] [Enabled]

Boot Up Floppy Seek [Disabled]

Enables or disables the chassis open status feature. Setting to Enabled, clears the chassis open status. Configuration options: [Disabled] [Enabled]

Bootup Num-Lock [On]

Allows you to select the power-on state for the NumLock. Configuration options: [Off] [On]

Typematic Rate Setting [Disabled]

Allows you to set the keystroke rate. Enable this item to configure the Typematic Rate (Chars/Sec) and the Typematic Delay (Msec). Configuration options: [Disabled] [Enabled]



The items **Typematic Rate (Chars/Sec)** and **Typematic Delay (Msec)** become user-configurable only when the item **Typematic Rate Setting** is enabled.

Typematic Rate (Chars/Sec) [6]

Allows you to select the rate at which a character repeats when you hold a key.
Configuration options: [6] [8] [10] [12] [15] [20] [24] [30]

Typematic Delay (Msec) [250]

Allows you to set the delay before keystrokes begin to repeat.
Configuration options: [250] [500] [750] [1000]

OS Select for DRAM > 64MB [Non-OS2]

Set this item to OS2 only when you are running on an OS/2 operating system with an installed RAM of greater than 64 MB. Configuration options: [Non-OS2] [OS2]

Full Screen LOGO [Enabled]

Allows you to enable or disable the full screen logo display feature.
Configuration options: [Disabled] [Enabled]



Make sure that the above item is set to [Enabled] if you want to use the ASUS MyLogo3™ feature.

Halt On [All Errors]

Allows you to set the error report type.
Configuration options: [All Errors] [No Errors] [All, But Keyboard] [All, But Diskette] [All, But Disk/Key]

4.7.6 Security

Phoenix-Award BIOS CMOS Setup Utility		
Boot		
Security		Select Menu
Supervisor Password	Clear	Item Specific Help▶▶
User Password	Clear	
Password Check	[Setup]	

Supervisor Password

User Password

These fields allow you to set passwords:

To set a password:

1. Select an item then press <Enter>.
2. Type in a password using a combination of a maximum of eight (8) alpha-numeric characters, then press <Enter>.

3. When prompted, confirm the password by typing the exact characters again, then press <Enter>. The password field setting is changed to Set.

To clear the password:

1. Select the password field and press <Enter> twice. The following message appears:



2. Press any key to continue. The password field setting is changed to Clear.

A note about passwords

The Supervisor password is required to enter the BIOS Setup program preventing unauthorized access. The User password is required to boot the system preventing unauthorized use.

Forgot your password?

If you forget your password, you can clear it by erasing the CMOS Real Time Clock (RTC) RAM. The RAM data containing the password information is powered by the onboard button cell battery. If you need to erase the CMOS RAM, refer to section “2.6 Jumper” for instructions.

Password Check

This field requires you to enter the password before entering the BIOS setup or the system. Select [Setup] to require the password before entering the BIOS Setup. Select [System] to require the password before entering the system.
Configuration options: [Setup] [System]

4.8 Tools menu

The Tools menu items allow you to configure options for special functions. Select an item then press <Enter> to display the sub-menu.

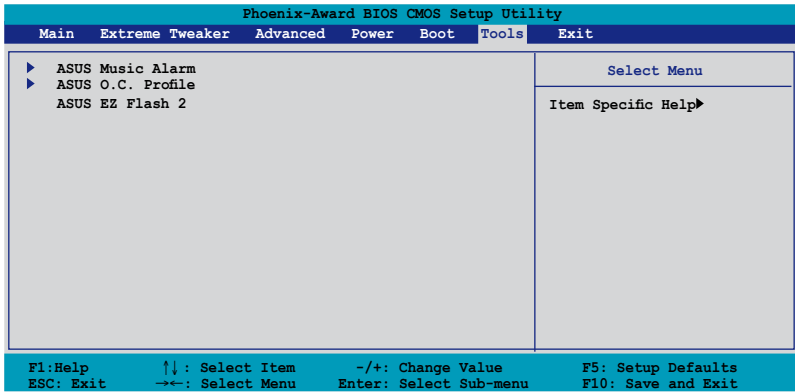

4.8.1 ASUS Music Alarm

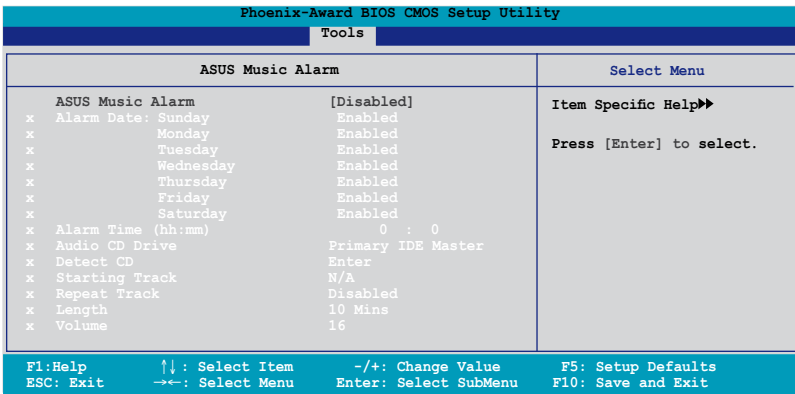

ASUS Music Alarm [Disabled]

Allows you to enable or disable the ASUS Music Alarm function.

Configuration options: [Disabled] [Enabled]



The succeeding items become user-configurable when you enable the ASUS Music Alarm.

Alarm Date: Sunday/Monday/Tuesday/Wednesday/Thursday/Friday/ Saturday [Enabled]

Allows you to enable or disable the alarm for a particular day.

Configuration options: [Disabled] [Enabled]

Alarm Time (hh:mm) 0 : 0

Allows you to set the alarm time. Press <Tab> to select the field, then use <+> or <-> to change the value. Configuration options: [Disabled] [Enabled]

Audio CD Drive [Primary IDE Master]

Allows you to select the connection configuration of the optical storage device from which the alarm music will play from.

Configuration options: [Primary IDE Master] [Primary IDE Slave]

Detect CD [Enter]

Press <Enter> to search the CD track number.

Starting Track

Allows you to choose the starting track from the CD from which you would like the alarm music to play.

Repeat Track [Disabled]

Allows you to enable or disable the repeat track function.

Configuration options: [Disabled] [Single] [All]

Length [10 Mins]

Allows you to set the length of the music alarm.

Configuration options: [10 Mins] [20 Mins] [30 Mins] [1 Hour]

Volume [16]

Allows you to set the volume level of the music alarm.

Configuration options: [01] ~ [32]

4.8.2 ASUS O.C. Profile

This item allows you to store or load multiple BIOS settings.

Phoenix-Award BIOS CMOS Setup Utility	
Tools	
ASUS BIOS Profile	Select Menu
▶ Load BIOS Profile ▶ Save BIOS Profile	Item Specific Help▶▶ Press [Enter] to select.

Load BIOS Profile

Phoenix-Award BIOS CMOS Setup Utility	
Tools	
Load BIOS Profile	Select Menu
Load from Profile 1 Load from Profile 2 Load from File	Item Specific Help▶▶ Load BIOS Profile from Profile 1.

Load from Profile 1/2

Allows you to load the previous BIOS settings saved in the BIOS Flash. Press <Enter> to load the file.

Load from File

Allows you to load the previous BIOS file saved in the hard disk/floppy disk/USB flash disk with the FAT32/16/12 format. Follow the instructions below to load the BIOS file.

1. Insert the storage devices that contains the “xxx.CMO” file.
2. Turn on the system.
3. Enter BIOS setup program. Go to the “Tools” menu to select “Load from File.” Press <Enter> then the setup screen will appear.
4. Press <Tab> to switch between drives before the correct “xxx.CMO” file is found. Then press <Enter> to load the file.
5. A pop-up message will inform you when the loading process finishes.



- Suggest only to update the BIOS file coming from the same memory/CPU configuration and BIOS version.
- Only the “xxx.CMO” file can be loaded.

Save BIOS Profile

Phoenix-Award BIOS CMOS Setup Utility	
Tools	
Save BIOS Profile	Select Menu
Save to Profile 1 Save to Profile 2 Save to File	Item Specific Help▶▶ Save current BIOS Profile to Profile 1.

Save to Profile 1/2

Allows you to save the current BIOS file to the BIOS Flash. Press <Enter> to save the file.

Save to File

Allows you to save the current BIOS file to the hard disk/floppy disk/USB flash disk with FAT32/16/12 format. Follow the instructions below to save the BIOS file.

1. Insert the storage devices with enough space.
2. Turn on the system.
3. Enter the BIOS setup program. Go to the “Tools” menu to select “Save to File.” Press <Enter> then the setup screen will appear.
4. Press <Tab> to switch between the drives. Press hot-key <S> to save the file.

5. Key in the file name. Then press <Enter>.
6. A pop-up message will inform you when the saving process finishes.

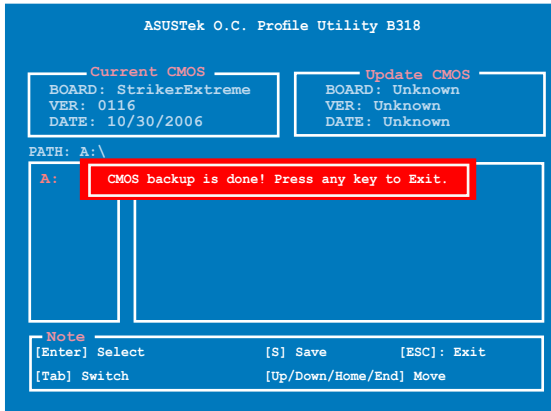

The BIOS file will be saved as "xxx.CMO".

4.8.3 ASUS EZ Flash 2

Allows you to run ASUS EZ Flash 2. When you press <Enter>, a confirmation message appears. Use the left/right arrow key to select between [Yes] or [No], then press <Enter> to confirm your choice.

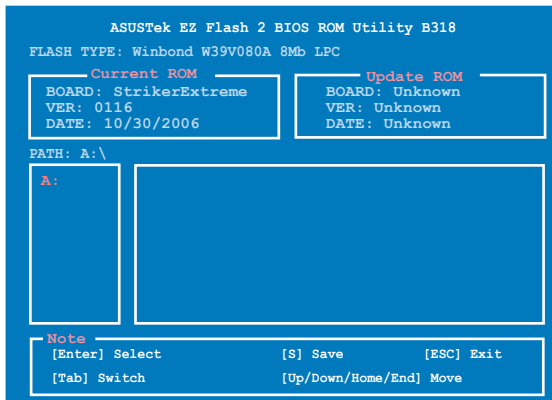

4.9 Exit menu

The Exit menu items allow you to load the optimal or failsafe default values for the BIOS items, and save or discard your changes to the BIOS items.

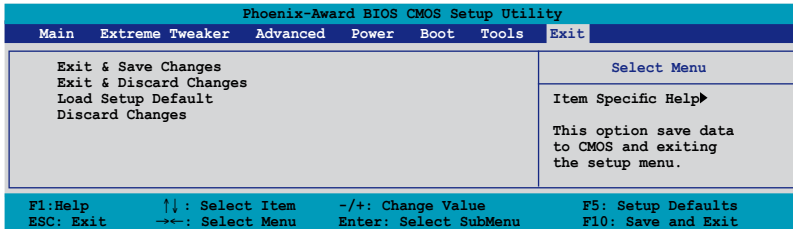

Pressing <Esc> does not immediately exit this menu. Select one of the options from this menu or <F10> from the legend bar to exit.

Exit & Save Changes

Once you are finished making your selections, choose this option from the Exit menu to ensure the values you selected are saved to the CMOS RAM. An onboard backup battery sustains the CMOS RAM so it stays on even when the PC is turned off. When you select this option, a confirmation window appears. Select YES to save changes and exit.



If you attempt to exit the Setup program without saving your changes, the program prompts you with a message asking if you want to save your changes before exiting. Press <Enter> to save the changes while exiting.

Exit & Discard Changes

Select this option only if you do not want to save the changes that you made to the Setup program. If you made changes to fields other than System Date, System Time, and Password, the BIOS asks for a confirmation before exiting.

Load Setup Default

This option allows you to load the default values for each of the parameters on the Setup menus. When you select this option or if you press <F5>, a confirmation window appears. Select YES to load default values. Select Exit & Save Changes or make other changes before saving the values to the non-volatile RAM.

Discard Changes

This option allows you to discard the selections you made and restore the previously saved values. After selecting this option, a confirmation appears. Select YES to discard any changes and load the previously saved values.

This chapter describes the contents of the support CD that comes with the motherboard package.

5 Software support

5.1	Installing an operating system	-51
5.2	Support CD information	5-1
5.3	Software information	5-9
5.4	RAID configurations	5-26
5.5	Creating a RAID driver disk.....	5-41

5.1 Installing an operating system

This motherboard supports Windows® 2000/2003 Server/XP/64-bit XP operating systems (OS). Always install the latest OS version and corresponding updates to maximize the features of your hardware.



- Motherboard settings and hardware options vary. Use the setup procedures presented in this chapter for reference only. Refer to your OS documentation for detailed information.
- Make sure that you install Windows® 2000 Service Pack 4 or the Windows® XP Service Pack 2 or later versions before installing the drivers for better compatibility and system stability.

5.2 Support CD information

The support CD that came with the motherboard package contains the drivers, software applications, and utilities that you can install to avail all motherboard features.



The contents of the support CD are subject to change at any time without notice. Visit the ASUS website(www.asus.com) for updates.

5.2.1 Running the support CD

Place the support CD to the optical drive. The CD automatically displays the Drivers menu if Autorun is enabled in your computer.

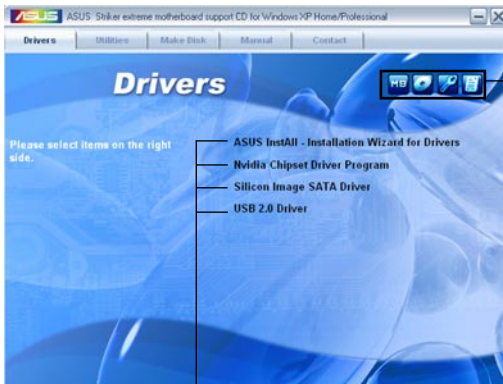

Click an icon to display support CD/motherboard information

Click an item to install



If Autorun is NOT enabled in your computer, browse the contents of the support CD to locate the file ASSETUP.EXE from the BIN folder. Double-click the ASSETUP.EXE to run the CD.

5.2.2 Drivers menu

The drivers menu shows the available device drivers if the system detects installed devices. Install the necessary drivers to activate the devices.



ASUS InstAll - Installation Wizard for Drivers

Launches the ASUS InstAll driver installation wizard.

Nvidia Chipset Driver Program

Installs the NVIDIA® Chipset drivers for the NVIDIA® nForce™ 680i SLI chipset.

Silicon Image SATA Driver

Installs the Silicon Image® Serial ATA driver.

USB 2.0 Driver

Installs the Universal Serial Bus 2.0 (USB 2.0) driver.

5.2.3 Utilities menu

The Utilities menu shows the applications and other software that the motherboard supports.

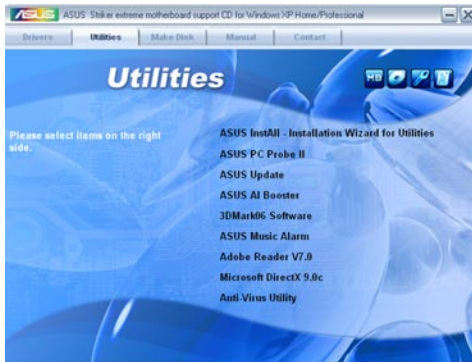

ASUS InstAll - Installation Wizard for Utilities

Launches the ASUS InstAll utilities installation wizard.

ASUS PC Probe II

This smart utility monitors the fan speed, CPU temperature, and system voltages, and alerts you of any detected problems. This utility helps you keep your computer in healthy operating condition.

ASUS Update

The ASUS Update utility allows you to update the motherboard BIOS in Windows® environment. This utility requires an Internet connection either through a network or an Internet Service Provider (ISP).

ASUS AI Booster

The ASUS AI Booster application allows you to overclock the CPU speed in Windows® environment.

3DMark06 Software

Installs the 3DMark06 software.

ASUS Music Alarm

The ASUS Music Alarm is an audio alarm clock that uses your favorite CD music to give you a personal wake-up call.

Adobe Reader V7.0

Installs the Adobe® Acrobat® Reader that allows you to open, view, and print documents in Portable Document Format (PDF).

Microsoft DirectX 9.0c

Installs the Microsoft® DirectX 9.0c driver. The Microsoft DirectX® 9.0c is a multimedia technology that enhances computer graphics and sound. DirectX® improves the multimedia features of your computer so you can enjoy watching TV and movies, capturing videos, or playing games in your computer. Visit the Microsoft website (www.microsoft.com) for updates.

Anti-Virus Utility

The anti-virus application scans, identifies, and removes computer viruses. View the online help for detailed information.

5.2.4 Make Disk menu

The Make Disk menu contains items to create the NVIDIA® nForce™ 680i SLI or Silicon Image SATA RAID driver disk.

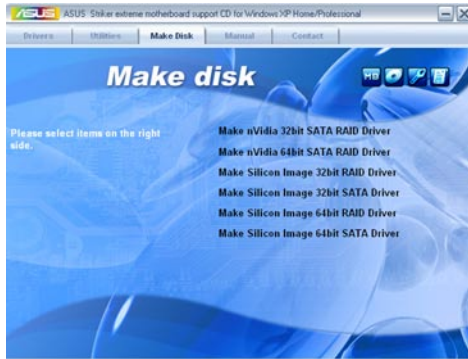

Make nVidia 32bit SATA RAID Driver

Make nVidia 64bit SATA RAID Driver

Allows you to create an NVIDIA® Serial ATA RAID driver disk for a 32-bit/64-bit system.

Silicon Image 32bit RAID Driver

Silicon Image 32bit SATA Driver

Allows you to create a Silicon Image® RAID/Serial ATA driver disk for a 32-bit system.

Silicon Image 64bit RAID Driver

Silicon Image 64bit SATA Driver

Allows you to create a Silicon Image® RAID/Serial ATA driver disk for a 64-bit system.

5.2.5 Manuals menu

The Manuals menu contains a list of supplementary user manuals. Click an item to open the folder of the user manual.



Most user manual files are in Portable Document Format (PDF). Install the Adobe® Acrobat® Reader from the Utilities menu before opening a user manual file.

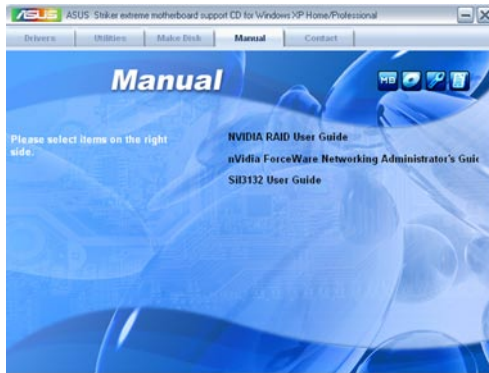

5.2.6 ASUS Contact information

Click the Contact tab to display the ASUS contact information. You can also find this information on the inside front cover of this user guide.



5.2.7 Other information

The icons on the top right corner of the screen give additional information on the motherboard and the contents of the support CD. Click an icon to display the specified information.

Motherboard Info

Displays the general specifications of the motherboard.



Browse this CD

Displays the support CD contents in graphical format.

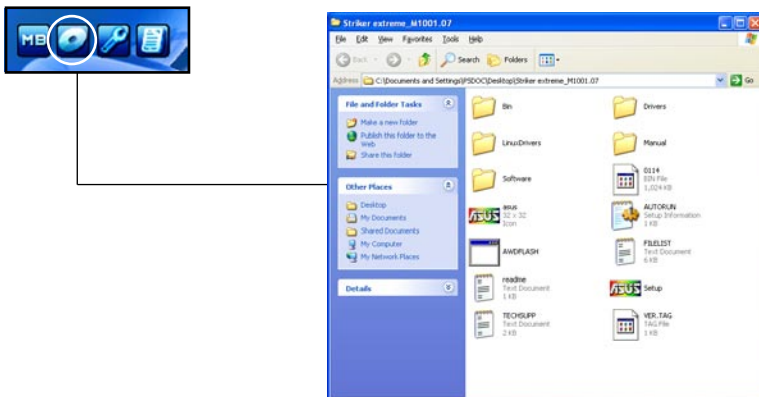

Technical support form

Displays the ASUS Technical Support Request Form that you have to fill out when requesting technical support.



```
ASUSTeK TECHNICAL SUPPORT REQUEST FORM
-----
ORIGINATOR DESCRIPTION
-----
COMPANY NAME: CONTACT NAME:
PHONE (AREA): FAX # (AREA):
EMAIL ADDRESS:
-----
HARDWARE DESCRIPTION
-----
MOTHERBOARD : REVISION #: BIOS(1#)Q/LAD-
CPU BRAND : SPEED(MHZ):
DRAM BRAND : SPEED(M#) : SIZE(MB):
CACHE BRAND : SPEED(M#) : SIZE(KB):
HARD DISK : MODEL NAME: SIZE(MB):
CDROM BRAND : MODEL NAME:
BACKUP BRAND : MODEL NAME: SIZE(MB):
OTHER STORAGE : MODEL NAME: SIZE(MB):
-----
MO-3H CARD DESCRIPTION (MODEL NAME/VENDOR)
-----
(E)ISA SLOT 1:
(V)ISA SLOT 2:
(V)ISA SLOT 3:
(E)ISA SLOT 4:
PCI-E SLOT 1:
PCI-E SLOT 2:
PCI-E SLOT 3:
PCI-E SLOT 4:
PCI SLOT 1:
PCI SLOT 2:
PCI SLOT 3:
PCI SLOT 4:
PCI SLOT 5:
-----
SOFTWARE DESCRIPTION
-----
OPERATING SYSTEM:
APPLICATION SOFTWARE:
DEVICE DRIVERS:
-----
PROBLEM DESCRIPTION (WHAT PROBLEMS AND UNDER WHAT SITUATIONS)
```

Filelist

Displays the contents of the support CD and a brief description of each in text format.



```
File list for the included support software for Striker extreme motherboard
-----
File Name Description
-----
-drivers
-Audio
-32bit -SoundMAX ADI1988 Audio Driver v5.10.1.4580 WHQL For W
-64bit -SoundMAX ADI1988 Audio Driver v5.10.2.4580 WHQL For W
-Chipset
-32bit
-xp -Nvidia Chipset Driver Package v9.13 for windows xp/2k
-w2kxp -Nvidia Chipset Driver Package v9.13 for windows 2000.
-64bit -Nvidia Chipset Driver Package v9.13 for windows 64bit
-RIS -Nvidia Chipset Configuring NVIDIA Networking Drivers
-DOS_ANDROID -DOS NO21 Ethernet and Network DOS CD Client Driver.
-RAID
-32bit-RAID -S11icon Image 3332 Raid 5 Driver v1.5.5.0 for windows
-32bit-SATA -S11icon Image 3332 Serial ATA Driver v2.0.13.0 For w1
-32bit-DOS-RAID -S11icon Image 3332 Raid 3 Driver v1.5.3.0 for windows
-32bit-DOS-SATA -S11icon Image 3332 Serial ATA Driver v1.0.15.0 for w1
-64bit-RAID -S11icon Image 3332 Raid 5 Driver v1.5.5.0 for windows
-64bit-SATA -S11icon Image 3332 Serial ATA Driver v2.0.8.0 For w1r
-64bit-DOS-RAID -S11icon Image 3332 Raid 3 Driver v1.5.3.0 for windows
-64bit-DOS-SATA -S11icon Image 3332 Serial ATA Driver v1.0.8.0 For w1r
-USB
-USB2.0 Driver Installation for windows 2000/xp.
-LinuxDrivers
-Support Linux Drivers.
-Manual
-user guide PDF file.
-Software
```

5.3 Software information

Most of the applications in the support CD have wizards that will conveniently guide you through the installation. View the online help or readme file that came with the software application for more information.

5.3.1 ASUS MyLogo3™

The ASUS MyLogo3™ utility lets you customize the boot logo. The boot logo is the image that appears on screen during the Power-On Self-Tests (POST). The ASUS MyLogo3™ is automatically installed when you install the ASUS Update utility from the support CD. See section “5.2.3 Utilities menu” for details.



- Before using the ASUS MyLogo3™, use the Award BIOS Flash utility to make a copy of your original BIOS file, or obtain the latest BIOS version from the ASUS website. See section “4.1.4 Updating the BIOS.”
- Make sure that the BIOS item Full Screen Logo is set to [Enabled] if you wish to use ASUS MyLogo3. See section “4.7.5 Boot Settings Configuration”.
- You can create your own boot logo image in GIF, or BMP file formats.
- The file size should be smaller than 150 K.

To launch the ASUS MyLogo3™:

1. Launch the ASUS Update utility. Refer to section “4.1.1 ASUS Update utility” for details.
2. Select **Options** from the drop down menu, then click **Next**.
3. Check the option **Launch MyLogo** to replace system boot logo before flashing BIOS, then click **Next**.
4. Select **Update BIOS** from a file from the drop down menu, then click **Next**.
5. When prompted, locate the new BIOS file, then click **Next**. The ASUS MyLogo window appears.
6. From the left window pane, select the folder that contains the image you intend to use as your boot logo.



- When the logo images appear on the right window pane, select an image to enlarge by clicking on it.



- Adjust the boot image to your desired size by selecting a value on the Ratio box.



- When the screen returns to the ASUS Update utility, flash the original BIOS to load the new boot logo.
- After flashing the BIOS, restart the computer to display the new boot logo during POST.

5.3.2 SoundMAX® High Definition Audio utility

The ADI AD1988B High Definition Audio CODEC provides 8-channel audio capability through the SoundMAX® audio utility with AudioESP™ software to deliver the ultimate audio experience on your PC. The software implements high quality audio synthesis/rendering, 3D sound positioning, and advanced voice-input technologies.

Follow the installation wizard to install the ADI AD1988B Audio Driver from the support CD that came with the motherboard package to activate the SoundMAX® audio utility.

-
- You must use 4-channel, 6-channel or 8-channel speakers for this setup.
 - SoundMAX® requires Microsoft® Windows® 2000/XP or later version. Make sure that one of these operating systems is installed before installing SoundMAX®.
 - Jack Retasking function works on High Definition front panel audio ports only.
-

If the SoundMAX® audio utility is correctly installed, you will find the SoundMAX® icon on the taskbar.



From the taskbar, double-click on the SoundMAX® icon to display the SoundMAX® Control Panel.



Audio Setup Wizard

By clicking the  icon from the SoundMAX® control panel, you can easily configure your audio settings. Simply follow succeeding screen instructions and begin enjoying High Definition Audio.



Jack configuration

This screen helps you configure your computer's audio ports, depending on the audio devices you have installed.



Adjust speaker volume

This screen helps you adjust speaker volume. Click the **Test** button to hear the changes you have made.



Adjust microphone volume

This screen helps you adjust microphone volume. You will be asked to read pre-written text to allow the AudioWizard to adjust the volume as you speak.



Audio preferences



Click the  icon to go to the Preferences page. This page allows you to change various audio settings.

General options

Click the General tab to choose your playback and recording devices, enable/disable the AudioESP™ feature, and enable/disable digital output.

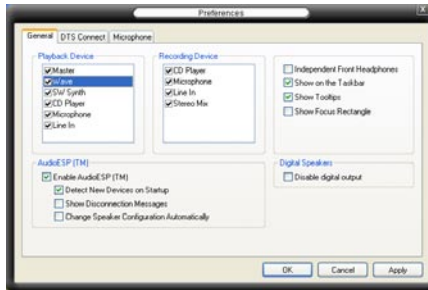

DTS

This feature consists of two elements: DTS interactive and DTS NEO:PC. DTS interactive re-encodes your stereo or multi-channel sound into a DTS audio signal and send it out from your PC to any DTS enabled system.

While DTS NEO:PC turns your stereo audio such as MP3, WMA, CD, and other sound format into a convincing multi-channel audio experience.

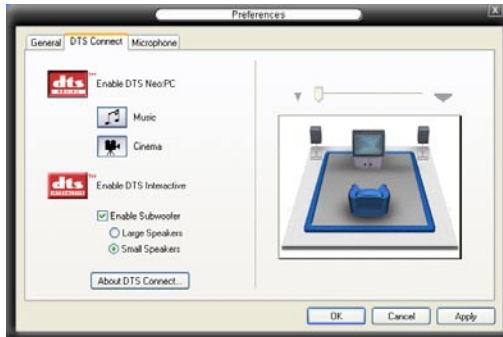

Microphone options

Click the Listening Environment tab allows you to optimize your microphone input settings.



Enhanced Microphone Features

Noise Filtering

Enables Noise Filter function. Detects repetitive and stationary noises like computer fans, air conditioners, and other background noises then eliminates it in the incoming audio stream while recording. You can enable it for a better recording quality.

Voice Recording

Receives only the sound coming from the reception cone and eliminates interferences including neighboring speakers and reverberations. You can enable it to transit clearer sound during on-line games, MSN, or Skype.

Directional Array

Advanced de-reverberation techniques can help to reduce echo and minimize its effect on the speech engine. You can enable it when you have conference call to reduce echoes in the other side.



The directional Array and Speaker Phone function only when working with the ASUS Array Mic.



5.3.3 ASUS PC Probe II

PC Probe II is a utility that monitors the computer's vital components, and detects and alerts you of any problem with these components. PC Probe II senses fan rotations, CPU temperature, and system voltages, among others. Because PC Probe II is software-based, you can start monitoring your computer the moment you turn it on. With this utility, you are assured that your computer is always at a healthy operating condition.

Installing PC Probe II

To install PC Probe II on your computer:

1. Place the support CD to the optical drive. The Drivers installation tab appears if your computer has an enabled Autorun feature.



If Autorun is not enabled in your computer, browse the contents of the support CD to locate the setup.exe file from the ASUS PC Probe II folder. Double-click the **setup.exe** file to start installation.

2. Click the **Utilities** tab, then click **ASUS PC Probe II**.
3. Follow the screen instructions to complete installation.

Launching PC Probe II

You can launch the PC Probe II right after installation or anytime from the Windows® desktop.

To launch the PC Probe II from the Windows® desktop, click **Start > All Programs > ASUS > PC Probe II > PC Probe II v1.xx.xx**. The PC Probe II main window appears.

After launching the application, the PC Probe II icon appears in the Windows® taskbar. Click this icon to close or restore the application.









Using PC Probe II

Main window

The PC Probe II main window allows you to view the current status of your system and change the utility configuration. By default, the main window displays the Preference section. You can close or restore the Preference section by clicking on the triangle on the main window right handle.



Click to close the Preference panel

Button	Function
	Opens the Configuration window
	Opens the Report window
	Opens the Desktop Management Interface window
	Opens the Peripheral Component Interconnect window
	Opens the Windows Management Instrumentation window
	Opens the hard disk drive, memory, CPU usage window
	Shows/Hides the Preference section
	Minimizes the application
	Closes the application

Sensor alert

When a system sensor detects a problem, the main window right handle turns red, as the illustrations below show.

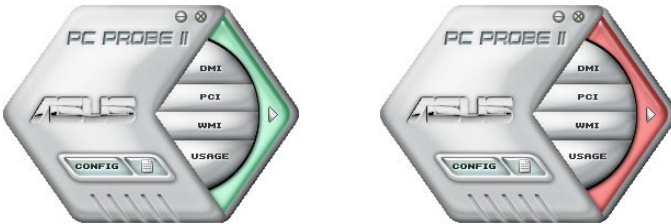

When displayed, the monitor panel for that sensor also turns red. Refer to the Monitor panels section for details.

Preferences

You can customize the application using the Preference section in the main window. Click the box before each preference to activate or deactivate.

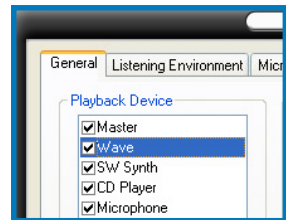

Hardware monitor panels

The hardware monitor panels display the current value of a system sensor such as fan rotation, CPU temperature, and voltages.

The hardware monitor panels come in two display modes: hexagonal (large) and rectangular (small). When you check the Enable Monitoring Panel option from the Preference section, the monitor panels appear on your computer's desktop.



Large display



Small display

Changing the monitor panels position

To change the position of the monitor panels in the desktop, click the arrow down button of the Scheme options, then select another position from the list box. Click OK when finished.



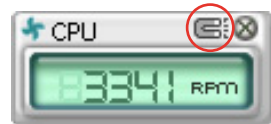

Moving the monitor panels

All monitor panels move together using a magnetic effect. If you want to detach a monitor panel from the group, click the horseshoe magnet icon. You can now move or reposition the panel independently.



Adjusting the sensor threshold value

You can adjust the sensor threshold value in the monitor panel by clicking the  or  buttons. You can also adjust the threshold values using the Config window.

You cannot adjust the sensor threshold values in a small monitoring panel.

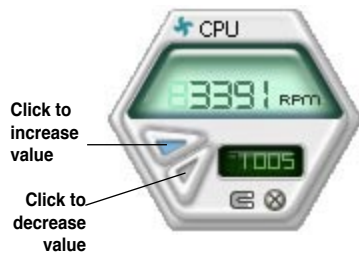

Monitoring sensor alert

The monitor panel turns red when a component value exceeds or is lower than the threshold value. Refer to the illustrations below.



Large display



Small display

WMI browser

Click **WMI** to display the WMI (Windows Management Instrumentation) browser. This browser displays various Windows® management information. Click an item from the left panel to display on the right panel. Click the plus sign (+) before WMI Information to display the available information.

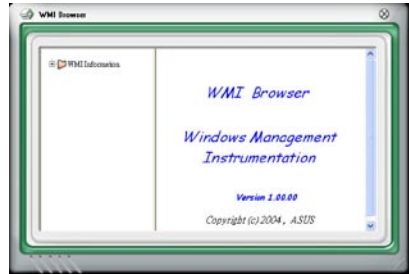

You can enlarge or reduce the browser size by dragging the bottom right corner of the browser.

DMI browser

Click **DMI** to display the DMI (Desktop Management Interface) browser. This browser displays various desktop and system information. Click the plus sign (+) before DMI Information to display the available information.



PCI browser

Click **PCI** to display the PCI (Peripheral Component Interconnect) browser. This browser provides information on the PCI devices installed on your system. Click the plus sign (+) before the PCI Information item to display available information.

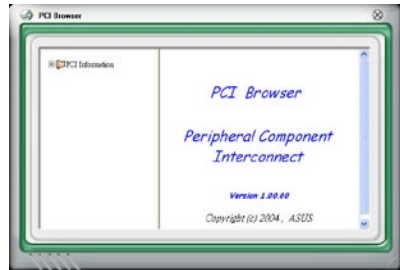

Usage

The Usage browser displays real-time information on the CPU, hard disk drive space, and memory usage. Click **USAGE** to display the Usage browser.

CPU usage

The CPU tab displays real-time CPU usage in line graph representation. If the CPU has an enabled Hyper-Threading, two separate line graphs display the operation of the two logical processors.

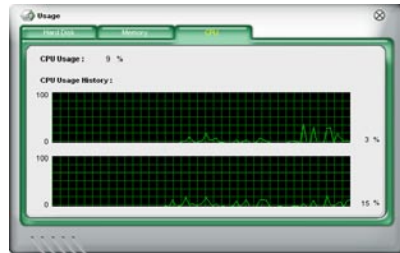

Hard disk drive space usage

The Hard Disk tab displays the used and available hard disk drive space. The left panel of the tab lists all logical drives. Click a hard disk drive to display the information on the right panel. The pie chart at the bottom of the window represents the used (blue) and the available HDD



Memory usage

The Memory tab shows both used and available physical memory. The pie chart at the bottom of the window represents the used (blue) and the available

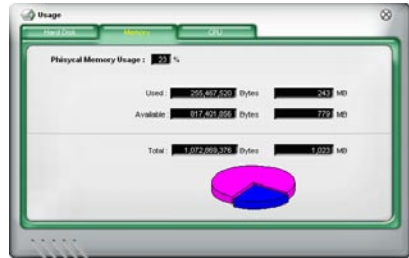

Configuring PC Probe II

Click **CONFIG** to view and adjust the sensor threshold values.

The Config window has two tabs: Sensor/Threshold and Preference. The Sensor/Threshold tab enables you to activate the sensors or to adjust the sensor threshold values. The Preference tab allows you to customize sensor alerts, or change the temperature scale.

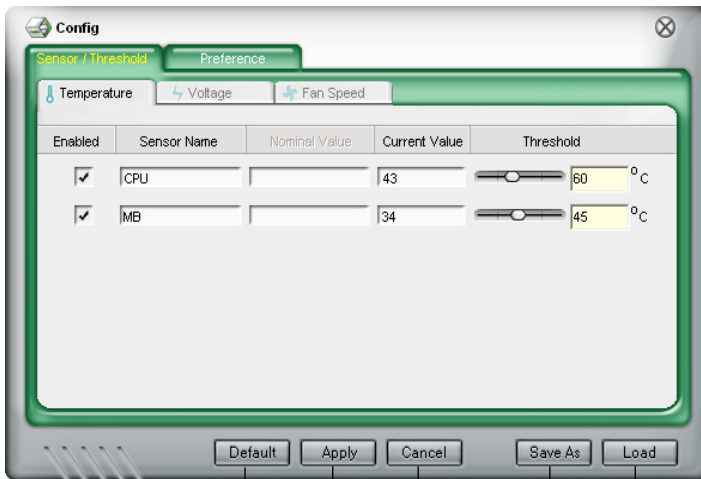

Loads the default threshold values for each sensor

Applies your changes

Cancels or ignores your changes

Loads your saved configuration
Saves your configuration

5.3.4 ASUS Music Alarm

This motherboard is equipped with an audio alarm clock called ASUS Music Alarm. The ASUS Music Alarm gives you a personal wake-up called with your favorite CD music when the system is off. The onboard audio CODEC supports this feature, which requires an optical drive (CD-ROM, CD-RW, or DVD-ROM).



-
- Make sure that the power cord is plugged to a grounded power source so that the system has standby power.
 - ASUS Music Alarm only supports audio CDs.
 - ASUS Music Alarm will not work if you installed and enabled an add-on sound card.
 - Only IDE ATAPI devices from the Southbridge support this feature.
-

Hardware setup

To set up the hardware:

1. Connect the analog audio cable from the optical drive to the 4-pin CD-In connector on the audio module.
2. Connect speakers or a headphone to the Line-Out (lime-colored) port on the front or rear panel for audio output. You may also connect speakers or a headphone to the output jack on the optical drive.
3. Refer to the succeeding sections to make the appropriate settings in the BIOS or in Windows®.

BIOS configuration

To enable ASUS Music Alarm in the BIOS:

1. Turn on the system.
2. During POST, press to enter BIOS setup.
3. Go to the **Tools** menu, then select **ASUS Music Alarm**.
4. Set the **ASUS Music Alarm** item to [Enabled]. See section “4.8.1 ASUS Music Alarm” for details.

OS configuration

To configure ASUS Music Alarm in Windows®

1. Place the support CD into the optical drive.
2. Click the **Utilities** tab and choose **ASUS Music Alarm** to install the utility.
3. Insert an audio CD into the optical drive.
4. Launch the ASUS Music Alarm application by going to **Start > ASUS > ASUS Music Alarm**. The main window appears.

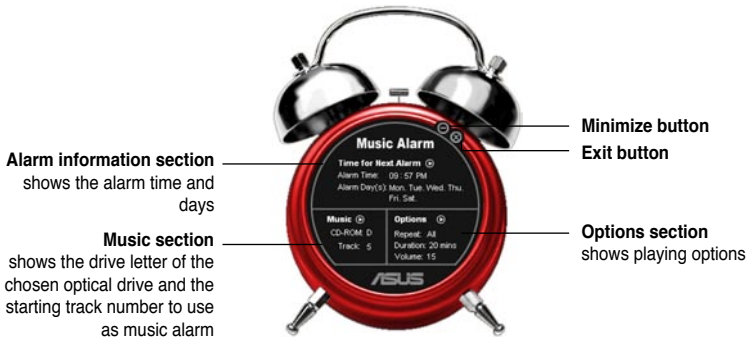

5. Click the arrow (▶) next to **Time for Next Alarm** in the Alarm information section. The Alarm Time Setting panel appears. Set the days and time of the alarm, or enable/disable the Music Alarm feature.

When done, click **OK**.



6. Click the arrow (▶) next to **Music** in the Music section. The Music Selection panel appears. Select the optical storage device, then choose the starting CD track number from which you would like the music alarm to play.

When done, click **OK**.



7. Click the arrow (▶) next to **Options** in the Options section. The Options panel appears. Disable or select the Repeat mode, then specify the length of the alarm music to play. Set the desired volume.

When done, click **OK**.



8. After you have finished making all the required settings, turn off the system.

Adjusting the volume

To adjust the volume while the music alarm is playing:

- Use the <Up> or <Down> arrow key to increase or decrease the volume.

Turning off the music alarm

To turn off the music alarm:

- Press any key to stop playing the CD and turn off the system.



-
- While the music alarm is playing, the system wake-up features (LAN, keyboard, mouse, PCI/PCIE device, modem) are deactivated.
 - If the system loses connection or if it does not detect any optical drive or audio CD, the ASUS Music Alarm is automatically disabled/turned off.
 - While the music alarm is playing, the optical drive front panel functions are automatically disabled.
 - The ASUS Music Alarm works only when the system is off.
-

5.3.5 ASUS Ai Booster

The ASUS Ai Booster application allows you to overclock the CPU speed in Windows® environment without the hassle of booting the BIOS.

After installing the program from the bundled support CD, you can launch the utility by double-clicking the Ai Booster icon on the Windows® OS taskbar.

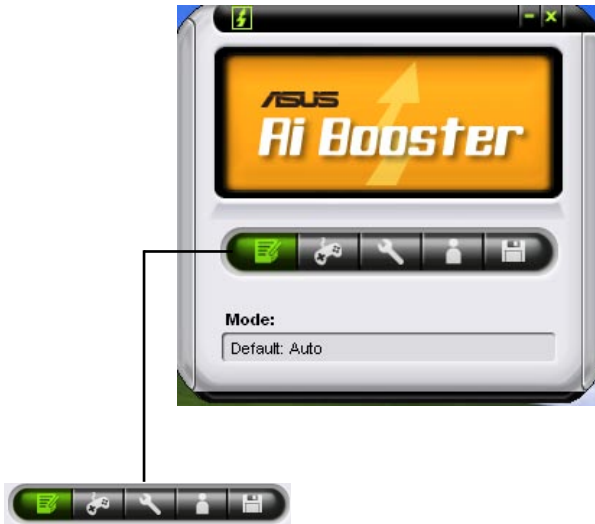

The options on the task bar allow you to use the default settings, adjust CPU/ Memory/PCI-E frequency manually, or create and apply your personal overclocking configurations.

5.4 RAID configurations

The motherboard comes with two RAID controllers that allow you to configure Serial ATA hard disk drives as RAID sets.

- The **Silicon Image® Sil3132** RAID controller allows you to configure RAID 1 and RAID 0 sets on the external Serial ATA hard disk drives.
- The **NVIDIA® nForce™ 680i SLI Southbridge** includes a high performance SATA RAID controller that supports RAID 0, RAID 1, RAID 0+1, RAID 5 and JBOD for six independent Serial ATA channels.

5.4.1 RAID definitions

RAID 0 (*Data striping*) optimizes two identical hard disk drives to read and write data in parallel, interleaved stacks. Two hard disks perform the same work as a single drive but at a sustained data transfer rate, double that of a single disk alone, thus improving data access and storage. Use of two new identical hard disk drives is required for this setup.

RAID 1 (*Data mirroring*) copies and maintains an identical image of data from one drive to a second drive. If one drive fails, the disk array management software directs all applications to the surviving drive as it contains a complete copy of the data in the other drive. This RAID configuration provides data protection and increases fault tolerance to the entire system. Use two new drives or use an existing drive and a new drive for this setup. The new drive must be of the same size or larger than the existing drive.

RAID 0+1 is data striping and data mirroring combined without parity (redundancy data) having to be calculated and written. With the RAID 0+1 configuration you get all the benefits of both RAID 0 and RAID 1 configurations. Use four new hard disk drives or use an existing drive and three new drives for this setup.

RAID 5 stripes both data and parity information across three or more hard disk drives. Among the advantages of RAID 5 configuration include better HDD performance, fault tolerance, and higher storage capacity. The RAID 5 configuration is best suited for transaction processing, relational database applications, enterprise resource planning, and other business systems. Use a minimum of three identical hard disk drives for this setup.

JBOD (*Spanning*) stands for Just a Bunch of Disks and refers to hard disk drives that are not yet configured as a RAID set. This configuration stores the same data redundantly on multiple disks that appear as a single disk on the operating system. Spanning does not deliver any advantage over using separate disks independently and does not provide fault tolerance or other RAID performance benefits.



If you want to boot the system from a hard disk drive included in a RAID set, first copy the RAID driver from the support CD to a floppy disk before you install an operating system to a selected hard disk drive. Refer to section “5.5 Creating a RAID driver disk” for details.

5.4.2 NVIDIA® RAID configurations

The motherboard includes a high performance SATA RAID controller integrated in the NVIDIA® nForce™ 680i SLI southbridge chipset. It supports RAID 0, RAID 1, RAID 0+1, RAID 5 and JBOD for six independent Serial ATA channels.

Installing Serial ATA (SATA) hard disks

The motherboard supports Ultra DMA 133/100/66 and Serial ATA hard disk drives. For optimal performance, install identical drives of the same model and capacity when creating a disk array.

To install the SATA hard disks for a RAID configuration:

1. Install the SATA hard disks into the drive bays.
2. Connect the SATA signal cables.
3. Connect a SATA power cable to the power connector on each drive.



Refer to the RAID controllers user manual in the motherboard support DVD for detailed information on RAID configurations. See section “5.2.5 Manuals menu.”

Setting the BIOS RAID items

After installing the hard disk drives, make sure to set the necessary RAID items in the BIOS before setting your RAID configuration.

To set the BIOS RAID items:

1. Boot the system and press during the Power-On Self-Test (POST) to enter the BIOS Setup Utility.
2. Enable the RAID Enabled item in the BIOS. See section “4.5.3 Onboard Device Configuration > Serial-ATA Configuration” for details.
3. Select and enable the IDE or SATA drive(s) that you want to configure as RAID. See section “4.5.3 Onboard Device Configuration > Serial-ATA Configuration” for details.
4. Save your changes and Exit Setup.



Make sure to re-enter your NVRAID settings after the CMOS is cleared; otherwise, the system will not recognize your RAID setup.



- For detailed descriptions on the NVIDIA® RAID configuration, refer to the “NVIDIA® RAID User Guide” found in your motherboard support CD.
 - When using Windows® 2000 operating system, make sure to install the Windows® 2000 Service Pack 4 or later version.
-

Entering the NVIDIA® RAID utility

To enter the NVIDIA® RAID utility:

1. Boot up your computer.
2. During POST, press <F10> to display the main menu of the utility.



The RAID BIOS setup screens shown in this section are for reference only, and may not exactly match the items on your screen.

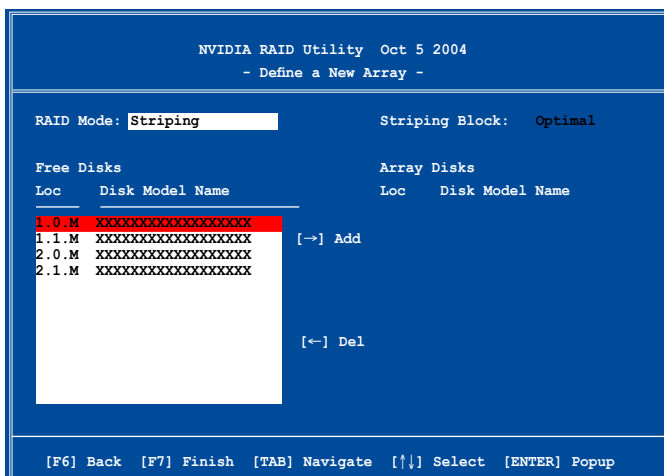

At the bottom of the screen are the navigation keys. These keys allow you to move through and select menu options.

Creating a RAID Volume

To create a RAID volume:

1. From the NVIDIA® RAID utility Define a New Array menu, select RAID Mode then press <Enter>. The following submenu appears.

Use the up or down arrow keys to select a RAID mode then press <Enter>.

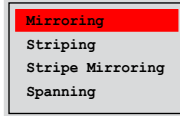

2. Press <TAB> select the Striping Block then press <Enter>. The following submenu appears:

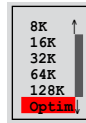

If you selected Striping or Stripe Mirroring, use the up or down arrow keys to select the stripe size for your RAID 0 array then press <Enter>. The available values range from 8 KB to 128 KB. The default selection is 128 KB. The stripe value should be chosen based on the planned drive usage.

- 8 /16 KB - low disk usage
- 64 KB - typical disk usage
- 128 KB - performance disk usage



TIP: For server systems, we recommend using a lower array block size. For multimedia computer systems used mainly for audio and video editing, we recommend a higher array block size for optimum performance.

3. Press <TAB> to select the Free Disks area. Use the left or right arrow keys to assign the array disks.
4. Press <F7> to create RAID set. The following message box appears.

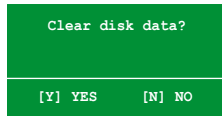

5. Press <Y> to clear the selected disks or <N> to proceed without clearing the disks. The following screen appears.



Take caution in using this option. All data on the RAID drives will be lost!

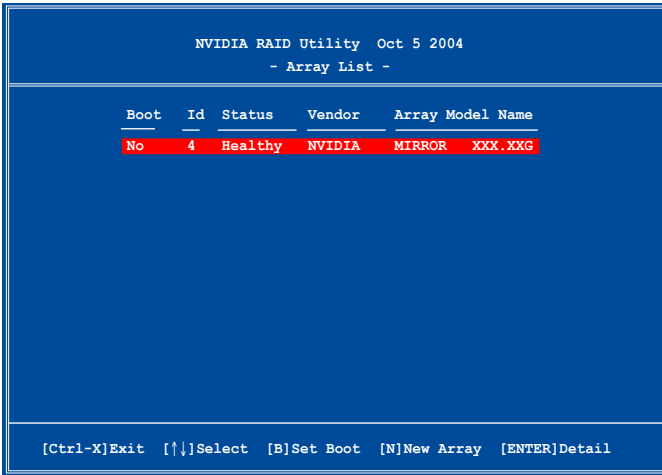

A new set of navigation keys is displayed on the bottom of the screen.

6. Press <Ctrl+X> to save settings and exit.

Rebuilding a RAID array

To rebuild a RAID array:

1. From the Array List menu, use the up or down arrow keys to select a RAID array then press <Enter>. The RAID Array details appear.

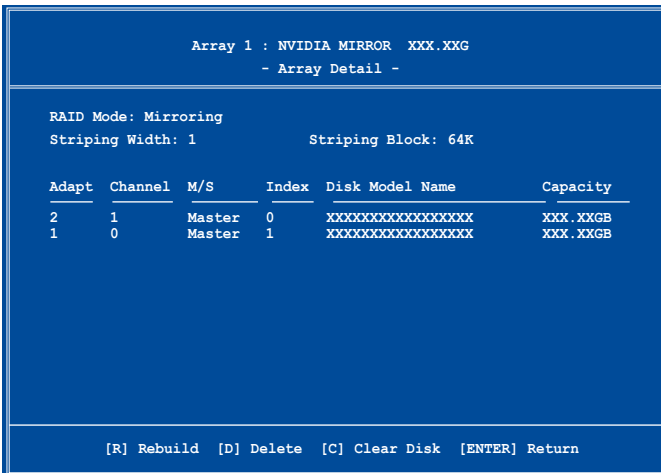

- A new set of navigation keys is displayed on the bottom of the screen.
2. Press <R> to rebuild a RAID array. The following screen appears.

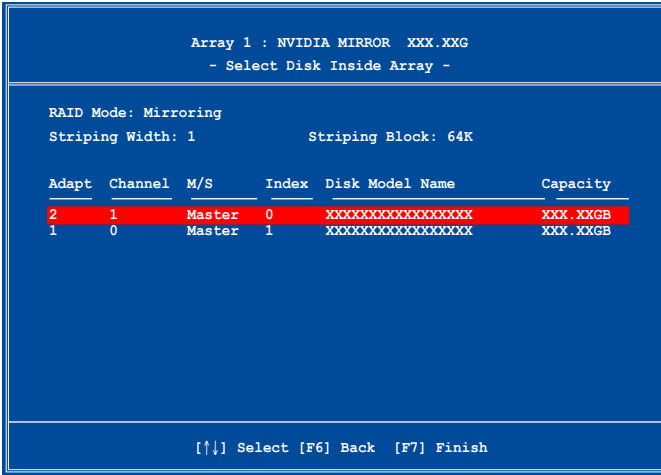

3. Use the up or down arrow keys to select a RAID array to rebuild, then press <F7>. The following confirmation message appears.



4. Press <Enter> to start rebuilding array or press <Esc> to cancel.
5. After the rebuild process, the Array list menu appears.



You will need to enter Window® XP and run the NVIDIA utility in order to complete the rebuilt process.

Deleting a RAID array

To delete a RAID array:

1. From the Array List menu, use the up or down arrow keys to select a RAID array then press <Enter>. The RAID Array details appear.

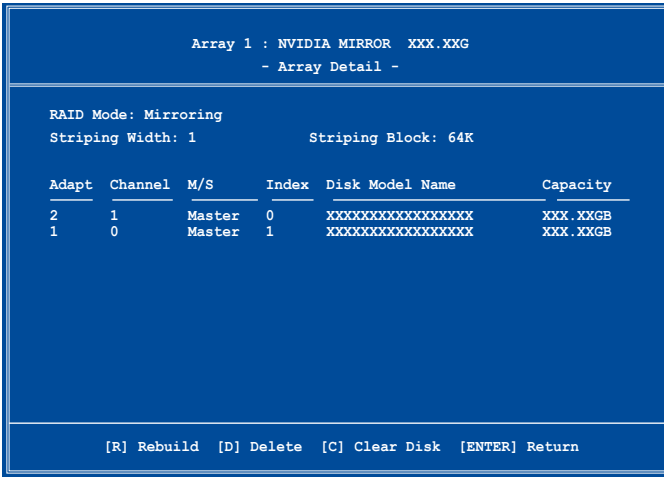

A new set of navigation keys is displayed on the bottom of the screen.

2. Press <D> to delete a RAID array. The following confirmation message appears.

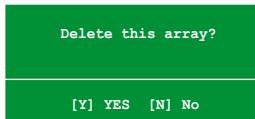

3. Press <Y> to delete array or press <N> to cancel.



Take caution in using this option. All data on the RAID drives will be lost!

4. If you selected Yes, the Define a New Array menu appears.

Clearing a disk data

To clear disk data:

1. From the Array List menu, use the up or down arrow keys to select a RAID array then press <Enter>. The RAID Array details appear.

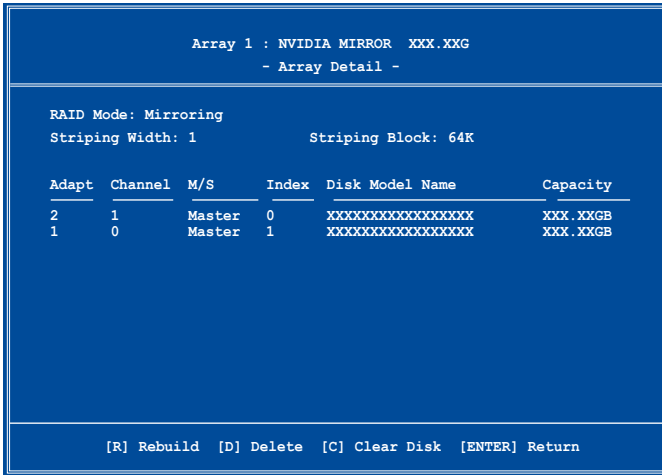

A new set of navigation keys is displayed on the bottom of the screen.

2. Press <C> to clear disk. The following confirmation message appears.

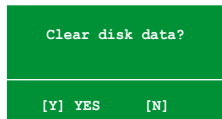

5. Press <Y> to clear the disk data or press <N> to cancel.



Take caution in using this option. All data on the RAID drives will be lost!

5.4.3 Silicon Image® RAID configurations

The Silicon Image® RAID controller allows you to configure RAID 1 and RAID 0 sets on the external Serial ATA hard disk drives. Use the Silicon Image RAID utility to configure a disk array.

Installing External Serial ATA (E-SATA) hard disks

To install the External SATA hard disks for a RAID configuration:

1. Connect one end of the E-SATA signal cables to the rear panel port.
2. Connect the other end of the E-SATA signal cables to the external SATA disk drives.



The installation procedure in this section is provided for reference only, refer to the user guide that comes with the external drive for detailed installation instructions.

Setting the BIOS RAID items

After installing the hard disk drives, make sure to set the necessary RAID items in the BIOS before setting your RAID configuration.

To set the BIOS RAID items:

1. Boot the system and press during the Power-On Self-Test (POST) to enter the BIOS Setup Utility.
2. From the **Advanced > Onboard Device Configuration** menu item in the BIOS set the Silicon SATA II Controller item to RAID Mode. See section “4.5.3 Onboard Device Configuration” for details.
3. Save your changes and Exit Setup.

Launching the Silicon Image Array Management Software

Launch the Silicon Image Array Management software from Windows® XP by clicking the **Start** button and selecting **All Programs > Silicon Image > Sam**



For details on the Silicon Image SATAraid™ RAID configuration, refer to the “Sil3132 User Guide” in your motherboard support CD.

Entering the Silicon Image BIOS RAID Configuration Utility

To enter the Silicon Image BIOS RAID configuration utility:

1. Boot up your computer.
2. During POST, press <Ctrl+S> or <F4>.



The RAID BIOS setup screens shown in this section are for reference only, and may not exactly match the items on your screen.

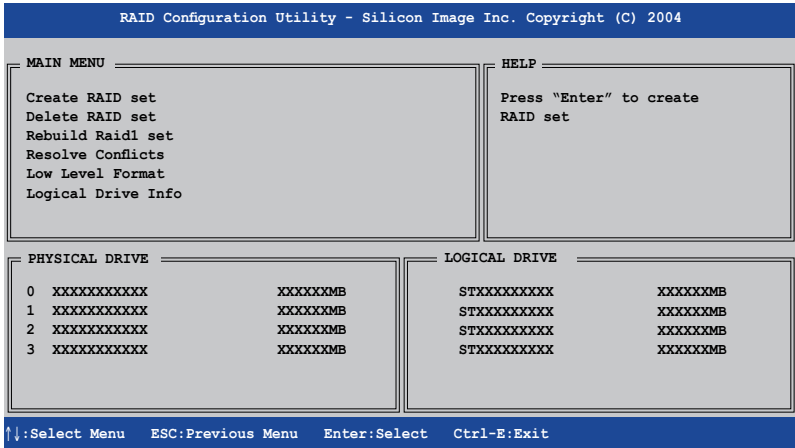

The Main Menu on the upper left corner allows you to select an operation to be performed. The Main Menu options include the following:

Create RAID set - creates a new legacy RAID set or allocates spare drives.

Delete RAID set - deletes a RAID set or deallocates a spare drive.

Rebuild RAID1 set - rebuilds a RAID 1 set (e.g., swapped drives).

Resolve Conflicts - automatically restores disrupted drives on a RAID set.

Low Level Format - creates a pattern of reference marks on a drive. Formatting the disks erases all data previously stored in the drive.

Logical Drive Info - shows the current configuration of each RAID set.

On the upper right corner of the screen is the **Help** message box. The message describes the function of each menu item. At the bottom of the screen is the legend box. The keys on the legend box allow you to navigate through the setup menu options. The following lists the keys found in the legend box and their corresponding functions.

- ↑, ↓ : Select/Move to the next item
- ESC** : Previous Menu
- Enter** : Select
- Ctrl-E** : Exit

Creating a RAID 0 set (Striped)

To create a RAID set:

1. From the Silicon Image configuration utility main menu, select Create RAID set then press <Enter> to display an option menu.

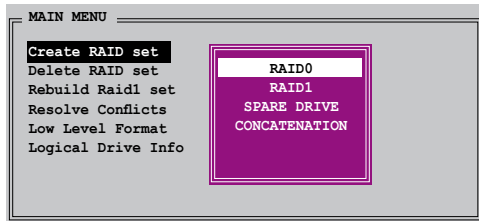

2. Select RAID 0 then press <Enter> to display the following.

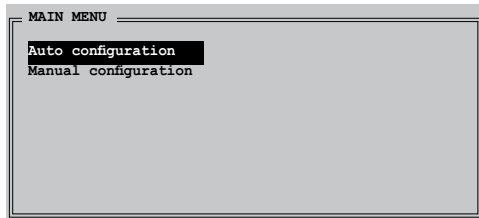

3. Select your desired method of configuration.
Auto configuration
 - a. Select Auto Configuration the press <Enter>.
 - b. The utility prompts a message to input the RAID size, use the up or down arrow keys to set the RAID size then press <Enter>.
 - c. Press <Y> to confirm or <N> to return to the Main Menu.



By default, Auto configuration sets the stripe size to 64K and sets the logical drives based on the physical drives installed.

Manual configuration

- a. Select Manual configuration and press <Enter>. The following pop-up menu appears.
- b. Use the up or down arrow keys to select a chunk size appropriate to your drive usage then press <Enter>.

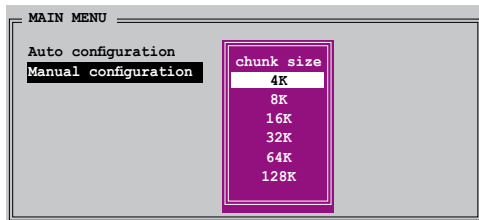



TIP: For server systems, we recommend using a lower array block size. For multimedia computer systems used mainly for audio and video editing, we recommend a higher array block size for optimum performance.

c. The selection bar moves to the Physical Drive menu. Using the up or down arrowkeys, select a drive then press <Enter> to set the first drive of the RAID set.

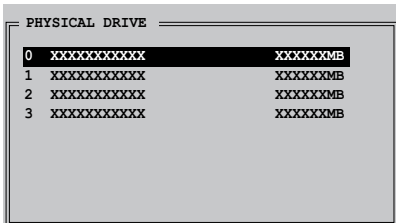

d. Repeat step c to set the second, third, and fourth drive. The number of available drives depend on the installed and enabled physical drives in the system.

e. The utility prompts a message to input the RAID size, use the up or down arrow keys to set the RAID size then press <Enter>.

f. Press <Y> to confirm or <N> to return to the Main Menu.

Creating a RAID 1 set (Mirrored)

To create a RAID 1 set:

1. From the Silicon Image configuration utility main menu, select Create RAID set then press <Enter>. The following sub-menu appears.

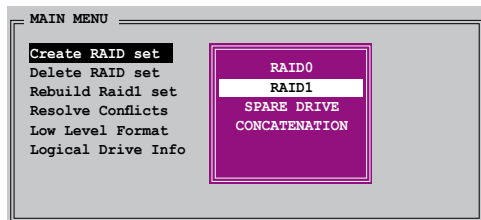

2. Select RAID 1 then press <Enter> to display the following.

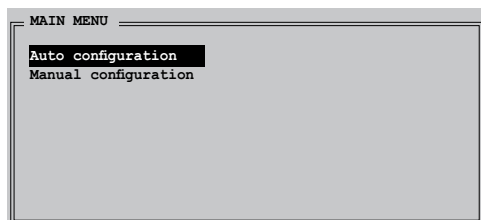

3. Select your desired method of configuration.

Auto configuration

- a. Select Auto Configuration then press <Enter>.
- b. The utility prompts a message to input the RAID size, use the up or down arrow keys to set the RAID size then press <Enter>.
- c. Press <Y> to confirm or <N> to return to the Main Menu.



- Auto-configuration creates a RAID 1 set without a backup copy of the current source disk data.
- When migrating a single hard disk drive to a RAID 1 set, use of the Manual configuration is recommended.

Manual configuration

- a. Select Manual configuration and press <Enter>. The selection bar moves to the Physical Drives menu.
- b. Using the up or down arrow keys, select the source drive and press <Enter>.

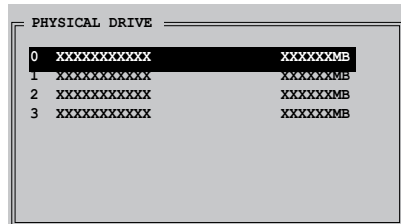

- c. Repeat step b to select the target drive.
- d. After selecting the source and target drives, the following pop-up menu appears.

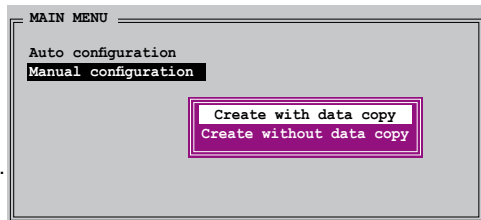

- The **Create with data copy** option allows you to copy the current data from the source drive to the mirror drive.
- Select **Create with data copy** if you have important data in your source drive.
- The **Create without data copy** option disables the disk copy function of the Mirrored set.
- If you selected **Create without data copy**, the RAID 1 set must be repartitioned and reformatted to guarantee the consistency of its contents.

- e. If you selected Create with data copy, the following pop-up menu appears.

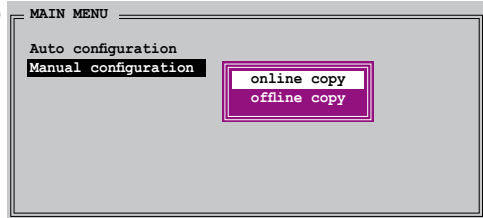

The online copy option automatically copies the data to the target drives on the background while writing to the source drives. The offline copy option allows you to copy the contents of the source drive to the target drives now.

- f. Use the up or down arrow keys to select desired copy method, then press <Enter>.
- g. The utility prompts a message to input the RAID size, use the up or down arrow keys to set the RAID size then press <Enter>.
- h. Press <Y> to confirm or <N> to return to the Main Menu.



A copy progress appears if you previously selected offline copy.

Creating a CONCATENATION set

To create a CONCATENATION set:

1. From the Silicon Image configuration utility main menu, select Create RAID set then press <Enter>.
2. From the sub-menu Select CONCATENATION then press <Enter>.

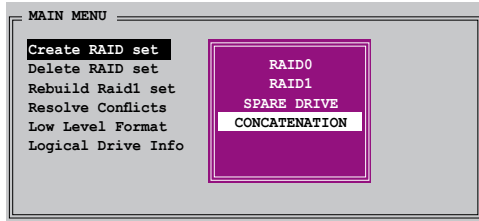

3. The selection bar moves to the Physical Drive menu. Using the up or down arrow keys, select a drive then press <Enter> to set a drive for the RAID set.
4. The utility prompts a message to input the RAID size, use the up or down arrow keys to set the RAID size then press <Enter>.
5. Press <Y> to confirm or <N> to return to the Main Menu.

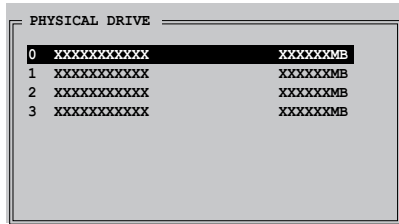

- Configure a CONCATENATION set when using a single Serial ATA drive; otherwise, the system will not recognize the drive.
- You can also create a RAID set using the SATARAID5 GUI utility under a Windows® environment.

5.5 Creating a RAID driver disk

A floppy disk with the RAID driver is required when installing Windows® 2000/XP operating system on a hard disk drive that is included in a RAID set.

To create a RAID driver disk:

1. Place the motherboard support DVD into the DVD-ROM drive.
2. Select Make Disk tab.
3. From the Make Disk menu, select the RAID driver disk you want to create or browse the contents of the support DVD to locate the driver disk utility.



Refer to section “5.2.4 Make Disk menu” for details.

4. Insert floppy disk to floppy disk drive.
5. Follow succeeding screen information to complete process.
6. Write-protect the floppy disk to avoid computer virus infection.

To install the RAID driver:

1. During the OS installation, the system prompts you to press the F6 key to install third-party SCSI or RAID driver.
2. Press <F6> then insert the floppy disk with RAID driver into the floppy disk drive.
3. Follow the succeeding screen instructions to complete the installation.



Due to chipset limitation, the Serial ATA ports supported by the NVIDIA chipset doesn't support Serial Optical Disk Drives (Serial ODD) under DOS.

This chapter tells how to install SLI-ready
PCI Express graphics cards.

NVIDIA[®] SLI[™] **technology support**

Chapter summary

6.1	Overview	6-1
6.2	Dual graphics cards setup	6-2

6.1 Overview

The motherboard supports the NVIDIA® SLI™ (Scalable Link Interface) technology that allows you to install two identical PCI Express™ x16 graphics cards. Follow the installation procedures in this section.

Requirements

- You should have two identical SLI-ready graphics cards that are NVIDIA® certified.
- Make sure that your graphics card driver supports the NVIDIA SLI technology. Download the latest driver from the NVIDIA website (www.nvidia.com).
- Make sure that your power supply unit (PSU) can provide at least the minimum power required by your system. See “8. ATX power connectors” on page 2-31 for details.



-
- The NVIDIA SLI technology supports Windows® XP™ 32-bit/64bit operating system only.
 - Visit the NVIDIA zone website (<http://www.nzone.com>) for the latest certified graphics card and supported 3D application list.
-

6.2 Dual graphics card setup

6.2.1 Installing SLI-ready graphics cards



Install only identical SLI-ready graphics cards that are NVIDIA®-certified. Different types of graphics cards will not work together properly.

To install the graphics cards:

1. Prepare two graphics cards. Each graphics card should have goldfingers for the SLI connector.

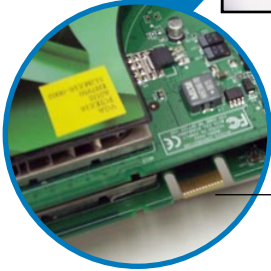

Goldfingers

2. Remove the metal bracket covers opposite the two PCI Express x16 slots.

3. Insert one graphics card into one of the blue slots (PCIEX16_1). Make sure that the card is properly seated on the slot.

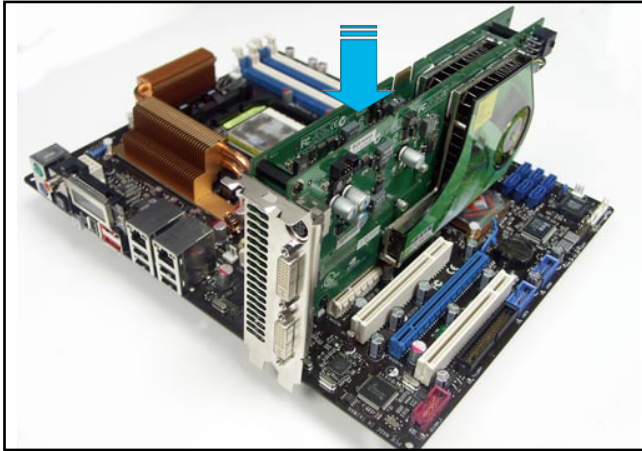

4. Insert the second graphics card into the other slot (PCIEX16_3). Make sure that the card is properly seated on the slot.

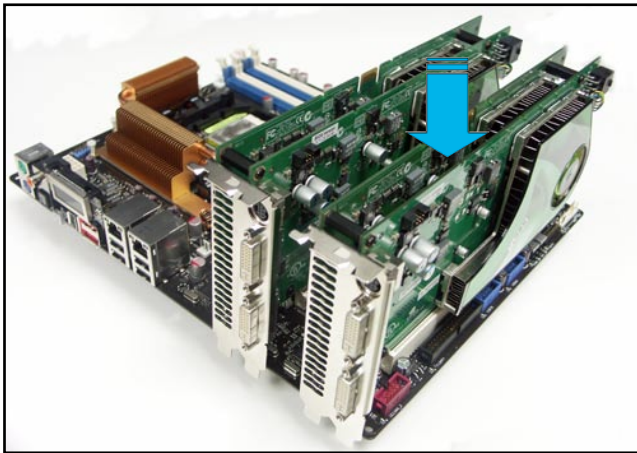

If required, connect an auxiliary power source to the PCI Express graphics cards.

5. Align and insert the SLI connector to the goldfingers on each graphics card. Make sure that the connector is firmly in place.

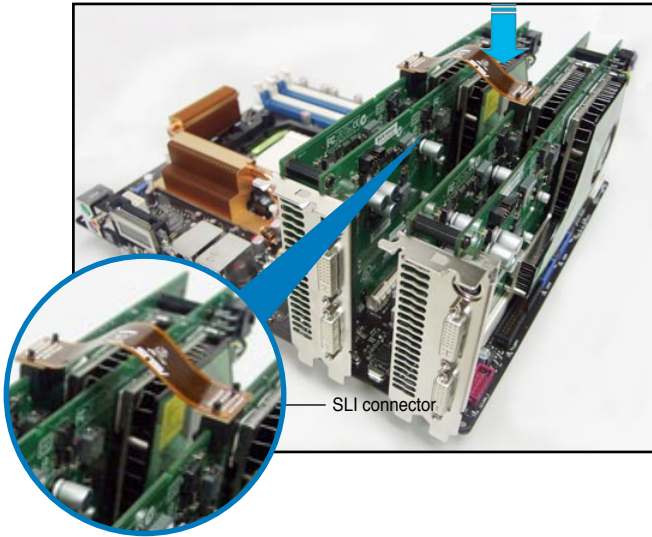

6. When installing two VGA cards using a 20-pin ATX PSU with sufficient+12v capability, we recommend that you connect the auxillary power source from the power supply to the graphics card. Refer to the PSU documentation for dual VGA power requirements.
7. Connect a VGA cable or a DVI-I cable to the graphics card/s.



We recommend to install an additional chassis fan for better thermal environment.

6.2.2 Installing the device drivers

Refer to the documentation that came with your graphics card package to install the device drivers.



Make sure that your PCI Express graphics card driver supports the NVIDIA SLI technology. Download the latest driver from the NVIDIA website (www.nvidia.com).

6.2.3 Enabling the multi-GPU feature in Windows®

After installing your graphics cards and the device drivers, enable the Multi-Graphics Processing Unit (GPU) feature in the NVIDIA nView properties.

To enable the multi-GPU feature:

1. Click the NVIDIA Settings icon on your Windows taskbar.



NVIDIA Settings icon

2. From the pop-up menu, select nView Desktop Manager then click nView Properties.

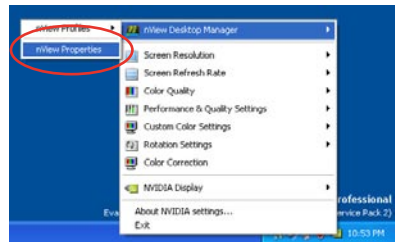

3. From the nView Desktop Manager window, select the Desktop Management tab.
4. Click Properties to display the Display Properties dialog box.

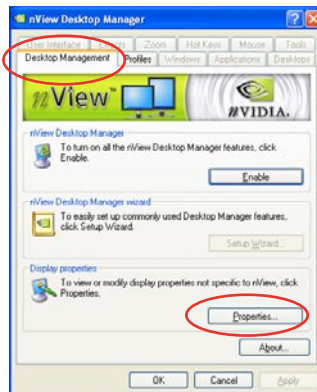

- From the Display Properties dialog box, select the Settings tab then click Advanced.



- Select the NVIDIA GeForce tab.

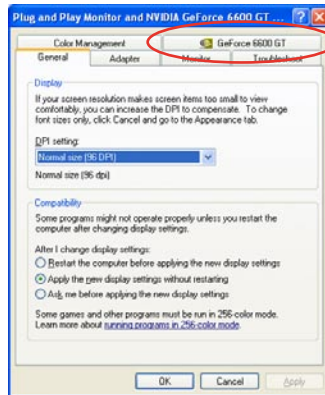

- Click the slider to display the following screen, then select the SLI multi-GPU item.

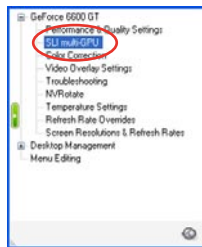

- Click the Enable SLI multi-GPU check box.
- Click OK when done.